

E-MANUAL

Thank you for purchasing this Samsung product.
To receive more complete service, please register
your product at

www.samsung.com/register

Model _____ Serial No. _____

Contents

Quick Guide

Using Smart Hub

Using Voice Control

Using Motion Control

Using the Samsung Smart Control

Using Multi-Link Screen

Connecting Antenna and External devices

Antenna Connection

Video Device Connections

9 HDMI Connection

10 Component Connection

11 Composite (A/V) Connection

Audio Input and Output Connections

12 HDMI (ARC) Connection

13 Digital Audio (Optical) Connection

14 Audio Output Connection

Connecting to a Computer

16 Connecting Through the HDMI Port

17 Connecting With a DVI to HDMI Cable

18 Connecting Through Samsung Link

18 Connecting Through DLNA Using Your Home Network

19 Connecting via Samsung Smart View 2.0

Connecting To a Mobile Device

20 Connecting With an MHL to HDMI Cable

21 Screen Mirroring

23 Connecting Mobile Devices without a Wireless Router (Wi-Fi Direct)

23 Connecting Through Samsung Link

24 Connecting Through DLNA Using Your Home Network

24 Connecting via Samsung Smart View 2.0

24 Specifying the Name of the TV on a Network

Switching Between Video Sources

25 Other Functions Available When You Display the Source List

25 The Universal Remote Function

Using the Remote Control and Peripherals

Installing Batteries into the Samsung Smart Control

26 The Low Battery Alarm Window

Pairing the Samsung Smart Control

27 Reconnecting the Samsung Smart Control

Using the Samsung Smart Control

28 Button Functions

31 Operating the TV by Moving the Samsung Smart Control

32 Using the Touch Pad and the Directional Buttons

34 Displaying and Using the On-Screen Remote

Controlling External Devices with the TV Remote - Using the Universal Remote

36 Connecting the IR Extender Cable

37 Setting Up the Universal Remote Control

38 Universal Remote Features

Controlling the TV with a Keyboard

39 Connecting a Keyboard

40 Using the Keyboard

Controlling the TV with a Mouse

41 Connecting a Mouse

42 Using the Mouse

Entering Text Using the On-Screen QWERTY Keypad

43 Using Additional Functions

Internet Connection

Establishing a Wired Internet Connection

44 Using Cat 7 LAN Cables

45 Connecting to a Wired Internet Network Automatically

46 Connecting to a Wired Internet Network Manually

Establishing a Wireless Internet Connection

- 48 Connecting to a Wireless Internet Network Automatically
- 49 Connecting to a Wireless Internet Network Manually
- 50 Connecting to a Wireless Internet Network with WPS

Troubleshooting Internet Connectivity Issues

- 51 Troubleshooting Wired Internet Connectivity Issues
- 52 Troubleshooting Wireless Internet Connectivity Issues

Checking the Internet Connection Status

Smart Features

Using Multiple Functions on a Single Screen (Multi-Link Screen)

- 54 Launching Multi-Link Screen
- 54 Using Multi-Link Screen

Smart Hub

- 56 Testing Smart Hub connections
- 57 Opening the First Screen
- 58 Moving to the Panel Screen
- 59 Using the Smart Hub Tutorial
- 59 Resetting Smart Hub

Using Smart Hub with a Samsung Account

- 60 Creating a Samsung Account
- 62 Signing in to a Samsung Account
- 63 Linking Your Samsung Account to External Service Accounts
- 64 Changing and Adding Information to a Samsung Account
- 64 Deleting a Samsung Account from the TV

Using the Games Panel

- 65 Using Supported Features via the Pop-Up Menu
- 66 Installing and Running a Game
- 67 Managing Downloaded or Purchased Games

Using the SAMSUNG APPS Panel

- 69 Using Supported Features via the Pop-Up Menu - Downloaded Apps
- 70 Using Supported Features via the Pop-Up Menu - Recommended Apps
- 70 Installing an App

Using the e-Manual

- 72 Launching the e-Manual
- 72 Additional e-Manual Features
- 73 Accessing the Menu from the e-Manual
- 73 Loading Reference Pages
- 73 Updating the e-Manual to the Latest Version
- 74 Using Web Browser
- 78 Relocating an App on the Apps Screen.
- 78 Deleting an App from the TV
- 79 Rating/Reviewing an App
- 79 Updating Apps
- 80 Using Other App Features and Functions

Using the On TV Panel

- 82 Using Supported Features via the Pop-Up Menu
- 82 Viewing Detailed Program Information
- 83 Configuring On TV Settings

Using the MOVIES & TV SHOWS Panel

- 85 Using Supported Features via the Pop-Up Menu
- 86 Watching a Movie/TV Program
- 86 Preventing Children from Watching Adult Content
- 87 Rating and Sharing a Purchased Content

Using the Multimedia Panel (Playing Photos, Videos, and Music)

- 89 Playing Media Content Saved on a USB Device
- 90 Playing Multimedia Content Saved on a Computer/Mobile Device
- 93 Buttons and Functions Available While Viewing Photos
- 94 Buttons and Functions Available While Viewing Videos
- 96 Buttons and Functions Available While Playing Music
- 97 Functions on the Media Content List Screen

Using the NewsON Panel

- 98 News
- 98 Weather

Using the SOCCER Panel

- 100 Setting Your Favorite Team

Controlling the TV with Your Voice (Voice Control)

- 101 Using Imperative Voice Control
- 103 Using Interactive Voice Control

Controlling the TV using Motions (Motion Control)

- 105 Testing Ambient Illumination Using the TV Camera
- 106 Activating Motion Control
- 108 Motion Control Screen Layout

Using Face Recognition

- 111 Registering Your Face to Your Samsung Account
- 112 Changing Your Login Method to Face Recognition
- 112 Signing in to a Samsung Account Using Face Recognition

TV Viewing

Digital Broadcast Information at a Glance

- 113 Using the Guide
- 114 Viewing Detailed Information
- 115 Checking Current Program Info
- 115 Changing the broadcast signal
- 115 Digital Channel Signal Info and Strength

Recording Programs

- 116 Formatting a USB Recording Device
- 118 Recording Programs
- 119 Buttons and Functions Available While Recording a Program
- 120 Managing the Schedule Recording List
- 121 Viewing Recorded Programs
- 124 Managing Recorded Files

Setting Up a Schedule Viewing

- 125 Digital Channel Schedule Viewing
- 126 Analog Channel Schedule Viewing
- 127 Canceling a Schedule Viewing
- 127 Editing a Schedule Viewing

Using Timeshift

Using the Channel List

Registering, Removing, and Editing Channels

- 130 Registering and Removing Channels
- 131 Editing Registered Channels
- 132 Program Rating Lock

Creating a Personal Favorites List

- 135 Registering Channels as a Favorites
- 136 Selecting from Favorite List Channels Only

Editing a Favorites List

- 137 Edit Favorites Screen Menu Items

Making Sports Programs More Realistic with Soccer Mode

- 140 Enabling Soccer Mode
- 140 Extracting Highlights Automatically
- 141 Functions Available While Watching Sports in Soccer Mode
- 142 Viewing a game recorded in Soccer Mode

TV-Viewing Support Features

- 143 Showing Captions
- 145 Enabling the Audio Guide for the Video Description
- 145 PIP Broadcast Viewing
- 146 Scanning for Available Channels
- 146 Selecting the Broadcast Audio Language
- 147 Fine-Tuning the Screen
- 147 Remove Scrambled Channels

Picture and Sound Settings

Changing the Picture Mode and Adjusting the Picture Quality

- 148 Choosing the Right Picture Mode for the Viewing Environment
- 149 Adjusting the Picture Quality for Each Picture Mode
- 150 Fine-Tuning Each Picture Mode (Advanced Settings)
- 152 Adjusting the Picture for Easier Viewing (Picture Options)

Viewing in 3D

- 154 Starting 3D
- 155 Changing the 3D Mode
- 156 Adjusting the 3D Effect

Picture Support Functions

- 157 PIP Broadcast Viewing
- 158 Changing the Picture Size and Position
- 159 Listening to Audio Only with the Screen Turned Off (Picture Off)
- 159 Resetting the Picture Mode Settings

Changing the Sound Mode and Using Sound Effects

- 160 Choosing the Right Sound Mode for the Environment
- 160 Using Sound Effects

Customizing Sound (Sound Customizer)

- 161 Customizing Sound
- 161 Using a Custom Sound Profile
- 162 Renaming and Deleting Custom Sound Profiles
- 162 Modifying a Custom Sound

Sound Support Functions

- 163 Selecting Speakers
- 164 Designating the TV's Installation Type
- 164 Listening to TV Sound through Samsung Bluetooth or Wi-Fi Audio
- 165 Listening to TV Sound through Samsung Multiroom Link compatible Speakers
- 166 Enabling Digital Audio Output
- 166 Listening to 3D Audio in 3D Mode
- 166 Resetting All Sound Settings

General

Setting the Time and Using the Timer

- 167 Setting the Current Time
- 169 Using the Timers

Using the Screen Burn Protection and Energy Saving Features

- 171 Preventing Screen Burn
- 171 Using Energy Saving Features

Using Anynet+ (HDMI-CEC)

- 172 Setting Up Anynet+ (HDMI-CEC)
- 173 Using Anynet+ (HDMI-CEC)

Updating the TV's Software

- 174 Update now
- 174 Online
- 175 Manually, Using a USB Flash Drive
- 176 Enabling Automatic Software Updates

Protecting the TV from Hacking and malicious code

- 176 Checking the TV and Connected Storage Media
- 177 Automatically Scanning when the TV is Powered On
- 177 Automatically Adding malicious code to the Blocked List

Using Other Functions

- 178 Setting Up a Password
- 178 Changing the Menu Language
- 178 Checking Notifications
- 179 Enabling Voice Guides for the Visually Impaired
- 180 Adjusting the Menu Transparency
- 180 White Text on Black Background (High Contrast)
- 181 Expanding the Smart Hub's Focus Area
- 181 Enabling/Disabling Sound Feedback
- 181 Locking/Unlocking the Panel Keys
- 181 Showing/Hiding the Samsung Logo while Booting
- 181 Enabling the TV to Boot Faster
- 182 Enabling/Disabling the Front Indicators
- 182 Enabling Game Mode
- 182 Enjoying Rich Colors and Superior Picture Quality (BD Wise)
- 183 Registering the TV as a DivX-Certified Device (Watching For Pay DivX Movies)
- 184 Restoring the TV to the Factory Settings
- 184 Using the TV as a Display Model (exclusively for retail stores)

Troubleshooting

Getting Support

- 185 Support through Remote Management
- 186 Finding the Information You Need for Service

There is a problem with the picture

- 187 Testing the Picture

I can't hear the sound clearly

- 189 Testing the Sound

I can't see 3D images clearly.

- 190 Testing 3D Picture Quality

There is a problem with the broadcast.

My computer won't connect.

I can't connect to the Internet.

The Schedule Recording/Timeshift function isn't working.

Anynet+ (HDMI-CEC) isn't working.

I am having trouble launching/using apps.

My file won't play.

I want to reset the TV.

Other Issues

Appendix

Before Using the Recording and Timeshift Functions

- 197 Before Using the Recording and Schedule Recording Functions
- 198 Before the Using Timeshift Function

Read Before Using 3D Viewing Mode

- 199 3D Precautions

S-Recommendation Disclaimer

- 202 S Recommendation with Voice Interaction
- 202 S Recommendation

Supported Resolutions for 3D Modes

- 203 HDMI
- 204 Component
- 204 Digital Channel
- 204 Videos/Photos
- 204 Computer via HDMI Cable.

Read Before Using Voice, Motion, or Face Recognition

- 205 Voice, Motion, and Face Recognition Precautions
- 207 Requirements for Using Voice, Motion, or Face Recognition

Read Before Using Apps

Read Before Using the Web Browser

Read Before Playing Photo, Video, or Music Files

- 212 Photo, Video, and Music File Use Limitations
- 212 Compatible Storage Devices for File Transfers
- 213 Supported External Subtitles
- 213 Supported Internal Subtitles
- 214 Supported Image Formats and Resolutions
- 214 Supported Music Formats and Codecs
- 215 Supported Video Codecs

Read After Installing the TV

- 217 Picture Sizes and Input Signals
- 217 Installing an Anti-Theft Lock
- 218 Read Before Setting Up a Wireless Internet Connection

Read Before Connecting a Computer (Supported Resolutions)

- 219 IBM
- 219 MAC
- 220 VESA DMT

Supported Resolutions for Video Signals

- 221 CEA-861

License

Glossary

Using Smart Hub

Usability depends on your specific model and local region.

- ✎ Connection and set up is not necessary if you connected the TV to the Internet and set up Smart Hub during the Initial Set up.

1 Connecting the TV to the Internet

1. Connect the TV to the Internet via a wired or wireless connection.
2. Set up Network Settings via MENU > Network > Network Settings.



The diagram shows two methods of internet connectivity. On the left, a TV is connected to a network via a white Ethernet cable plugged into its back. On the right, a TV is connected wirelessly to a white Wi-Fi router, with yellow signal waves emanating from both the TV and the router.

2 Setting up Smart Hub

The first time you start Smart Hub, you need to set it up. Follow the directions on the screen.

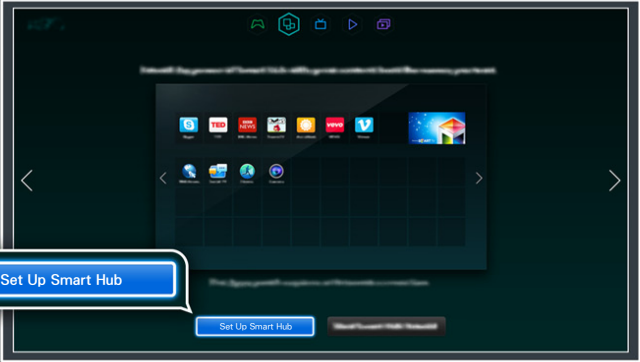

The screenshot shows the Smart Hub interface with a grid of application icons. A blue callout box with a white border points to a button labeled 'Set Up Smart Hub' at the bottom of the screen. The background is dark with a grid of icons including YouTube, Netflix, and others.

3 Using Smart Hub

Go to Smart Hub > SAMSUNG APPS and download applications to your Samsung Smart TV.

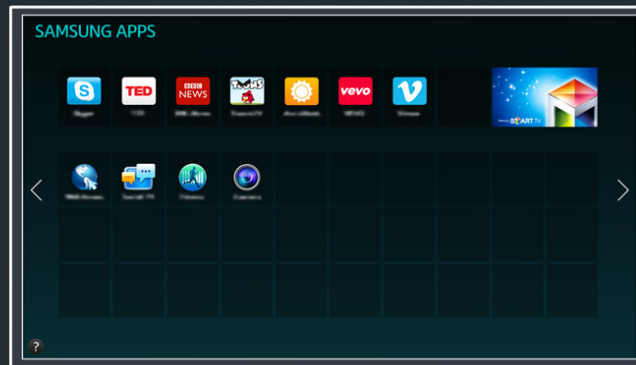

 For more information, refer to "Smart Hub".

Using Voice Control

1 Setting up Voice Control

Set up Voice Control via MENU > System > Voice Control.

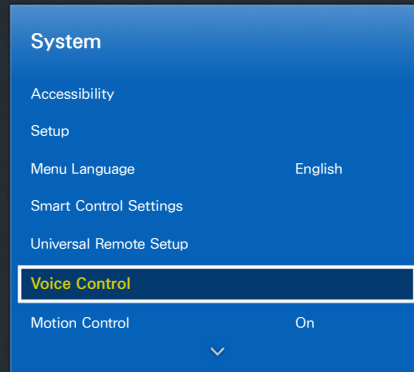

2 Using Voice Control

Press the VOICE button on the Samsung Smart Control, and then say the desired commands.

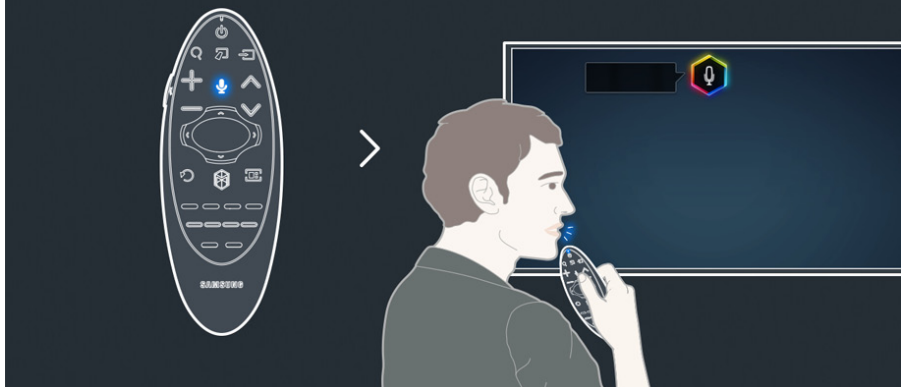

 For more information, refer to "Controlling the TV with Your Voice (Voice Control)".

Using Motion Control

1 Setting up Motion Control

Set up parameters for Motion Control via MENU > System > Motion Control.

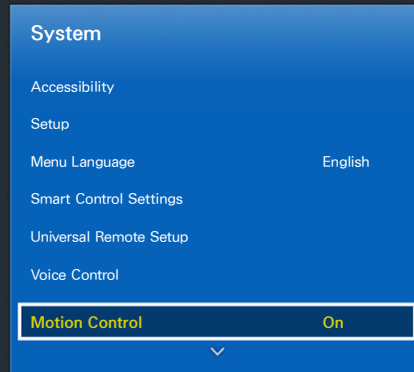

2 Using Motion Control

1. Raise your hand with your index finger extended. Move your hand slowly left and right. A pointer appears on the screen.
2. Move your hand to move the pointer on the screen. Fold down and then raise your index finger to select items.

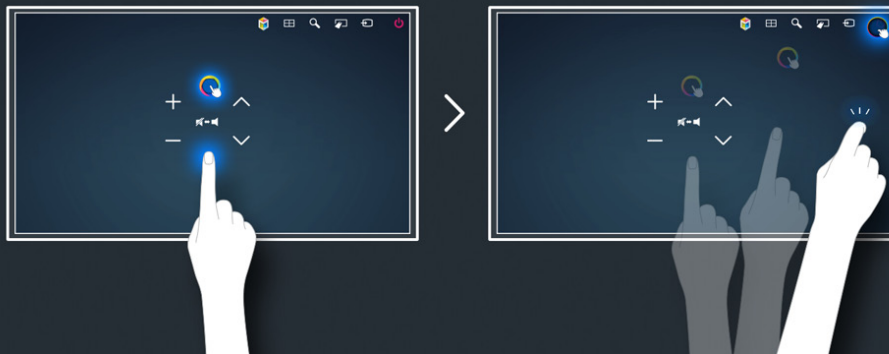

 To use Motion Control, you must connect a TV camera (sold separately) to the TV.

 For more information, refer to "Controlling the TV using Motions (Motion Control)".

Using the Samsung Smart Control

Pair the Samsung Smart Control to the TV the first time by pressing the Power button on the Samsung Smart Control. To pair again - if necessary - press the **RETURN** and **GUIDE** buttons simultaneously for 3 seconds or more.

1 Pairing with the TV

To pair again, press RETURN and GUIDE simultaneously for 3 seconds or more.



2 Setting the Samsung Smart Control

Set the Smart Control Settings via MENU > System > Smart Control Settings.

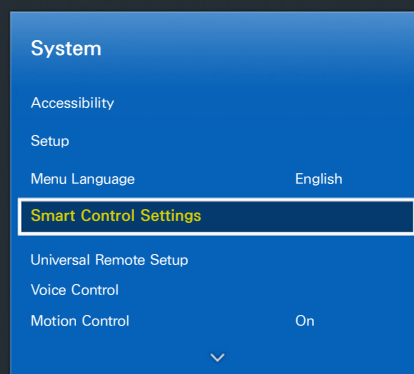

3 Using the Samsung Smart Control

Use the buttons to perform actions.



Place a finger on the touch pad, and then move the Samsung Smart Control. The pointer moves on the screen.



 For more information, refer to "Using the Samsung Smart Control".

Using Multi-Link Screen

1 Running Multi-Link Screen

Press the M.SCREEN button.



2 Using the Multi-Link Screen

Search the web, use apps, and watch TV at the same time using Multi-Link. While Multi-Link is running, press the M.SCREEN button to select additional features or options.

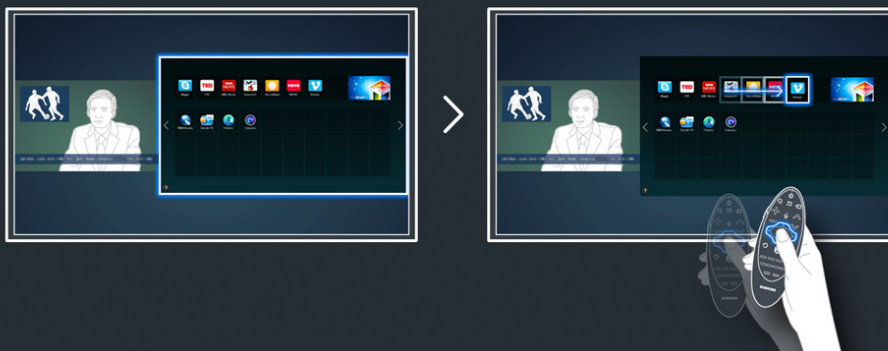

 For more information, refer to "Using Multiple Functions on a Single Screen (Multi-Link Screen)".

Antenna Connection

If you are not connecting your TV to a cable or satellite box, you must connect an antenna or a cable outlet to the TV to receive broadcast signals.

Connect a cable from an antenna or cable outlet to the ANT IN connector as shown in the diagram below.

 An antenna connection is not necessary when a cable box or satellite receiver is used.

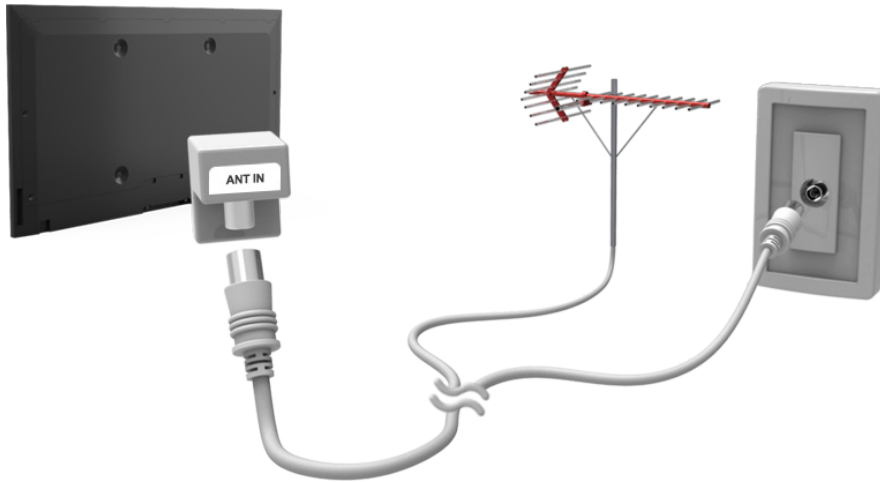



Video Device Connections

Your TV has a variety of connectors for video input from external devices such as cable boxes, satellite receivers, Blu-ray players, DVD players, camcorders, and gaming consoles. Below is a list of featured connectors shown in descending order of picture quality.

- HDMI
- Component
- Composite (A/V)

Connect a video device to the TV via an HDMI connector for the best picture quality. If the device does not have an HDMI connector, try a component connector to get the next best picture quality.

 The number of connectors and their names and locations may vary depending on the model.

 Refer to the external device's operating manual when connecting it to the TV. The number of external device connectors and their names and locations may vary depending on the manufacturer.

HDMI Connection

The following types of HDMI cables are recommended:

- High-Speed HDMI Cable
- High-Speed HDMI Cable with Ethernet

- ✎ Use an HDMI cable with a thickness of 0,55 inches (14mm) or less.
- ✎ Using a non-certified HDMI cable may result in a blank screen or a connection error.
- ✎ Some HDMI cables and devices may not be compatible with the TV due to different HDMI specifications.
- ✎ This TV does not support HDMI Ethernet Channel. Ethernet is a LAN (Local Area Network) built with coaxial cables standardized by the IEEE.

Refer to the diagram and connect the HDMI cable to the video device's HDMI output connector and the TV's HDMI input connector.

- ✎ The number of connectors and their names and locations may vary depending on the model.



Once the connection has been made, press the **SOURCE** button to select the connected external device.

Component Connection

Refer to the diagram and connect the Component cable to the TV's component input connectors and the device's component output connectors.

Make sure the cable colors match the connector colors.

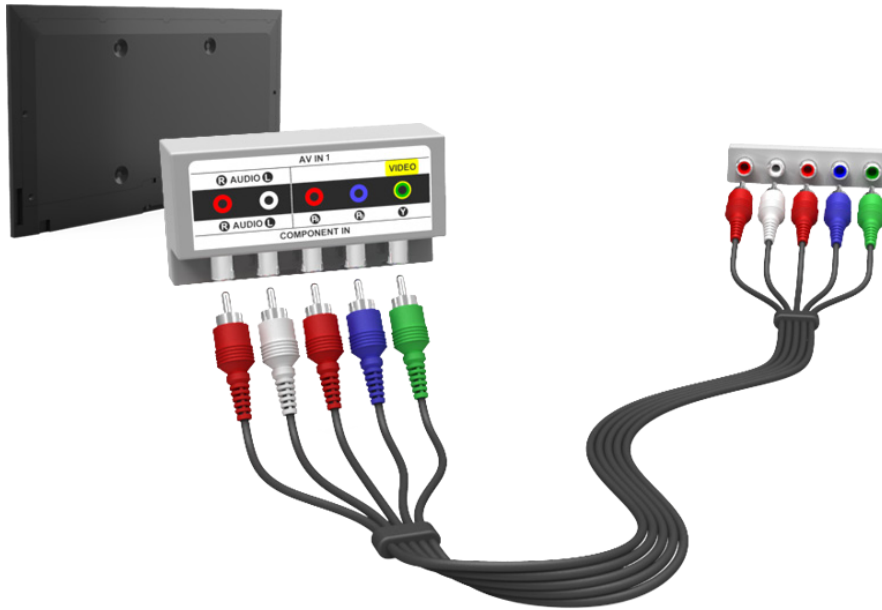

Once the connection has been made, press the **SOURCE** button to select the connected external device.

Composite (A/V) Connection

Refer to the diagram and connect the AV cable to the TV's AV input connectors and the device's AV output connectors.

If you are using the TV's AV1 input connectors, connect the device's audio output to the TV using a Y connector.

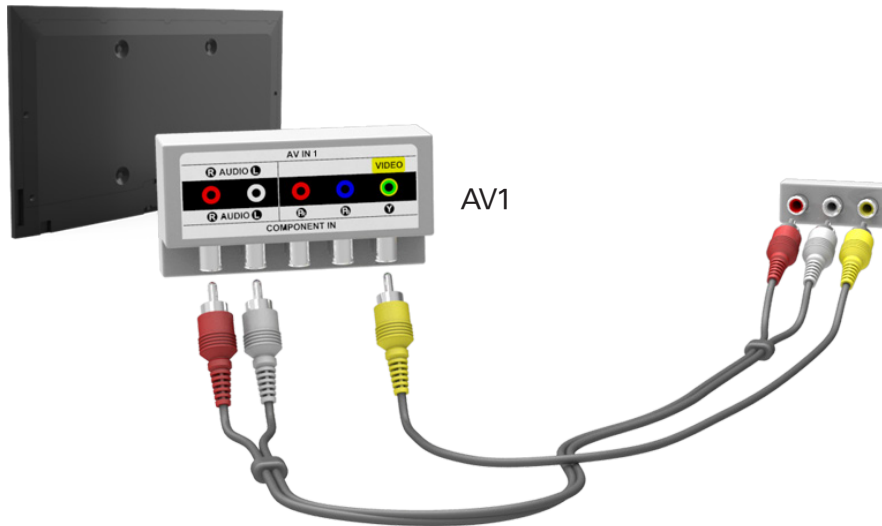

If you are using the TV's AV2 input connectors, use the included AV connection adapter to connect the device's audio and video output to the TV.

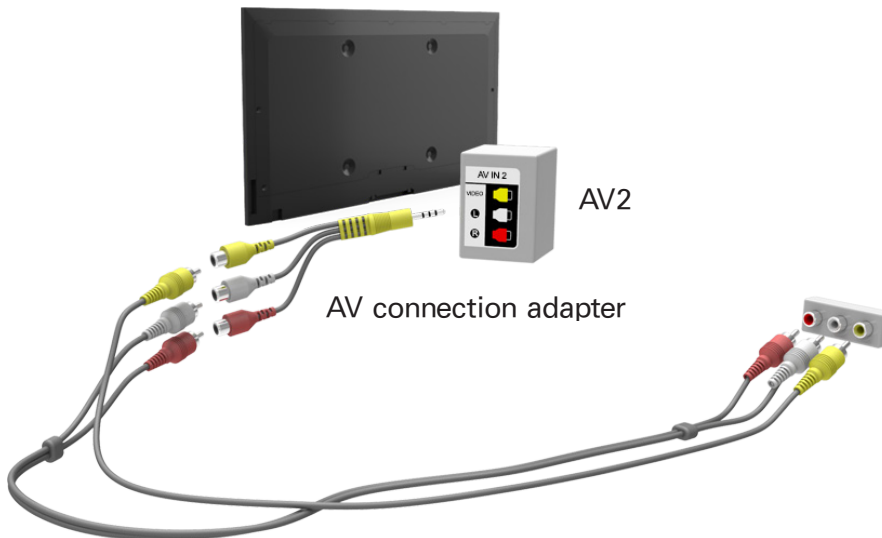



Once the connection has been made, press the **SOURCE** button to select the connected external device.

Audio Input and Output Connections

Your TV has a variety of connections for audio input from devices such as Blu-ray players and DVD players and for audio output to such devices as amplifiers. The connections are listed below.

- HDMI/ARC (Audio Return Channel)
- Digital Audio (Optical)
- Audio (Analog)

-  For better audio quality, it is a good idea to use an AV receiver.
-  The number of connectors and their names and locations may vary depending on the model.
-  Refer to the external device's operating manual when connecting it to the TV. The number of external device connectors and their names and locations may vary depending on the manufacturer.

HDMI (ARC) Connection

ARC lets the TV output digital sound to an audio device and input digital sound from the same audio device through one HDMI cable. ARC is only available through the HDMI (ARC) port and only when the TV is connected to an ARC-enabled AV receiver.

-  Certain functions such as Smart Hub may not be available if the **Source** is set to HDMI and **3D Auto View** is set to **On**. If this is the case, set **3D Auto View** or **3D Mode** to **Off**.

Connect an HDMI cable to the TV's HDMI (ARC) connection and the device's HDMI output connection.

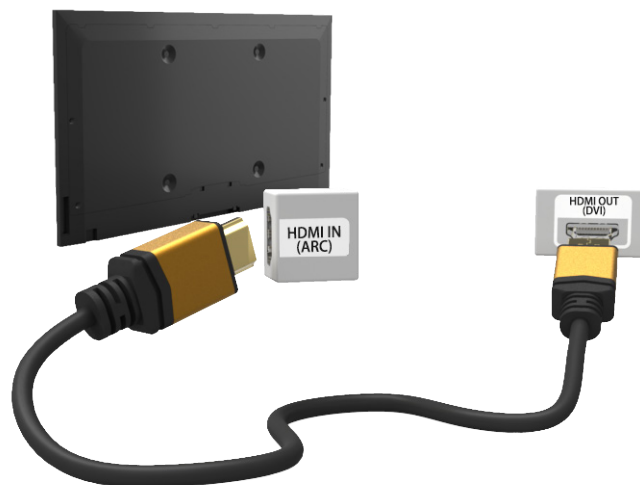

Digital Audio (Optical) Connection

Connecting an AV receiver to the TV via a digital audio (optical) connector lets you listen to digital audio.

- ✎ Connecting a device using an optical cable does not automatically turn off the TV speakers. To turn off the TV's speakers, set **TV Sound Output** (**Sound** > **Speaker Settings** > **TV Sound Output**) to something other than TV Speaker.
- ✎ Adjust the audio device's volume using its remote control.
- ✎ An unusual noise coming from the audio device while you are using it may indicate a problem with the audio device itself. If this occurs, ask for assistance from the audio device's manufacturer.
- ✎ Digital audio is only available with 5.1-channel broadcasts.

Refer to the diagram and connect the optical cable to the TV's digital audio output connector and the device's digital audio input connector.

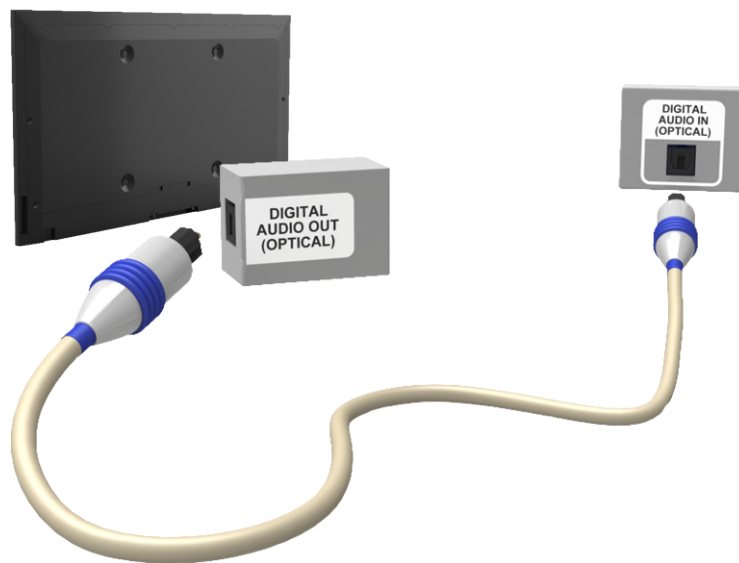

Audio Output Connection

Refer to the diagram and connect an audio cable to the TV's audio output connector and the device's audio input connector.

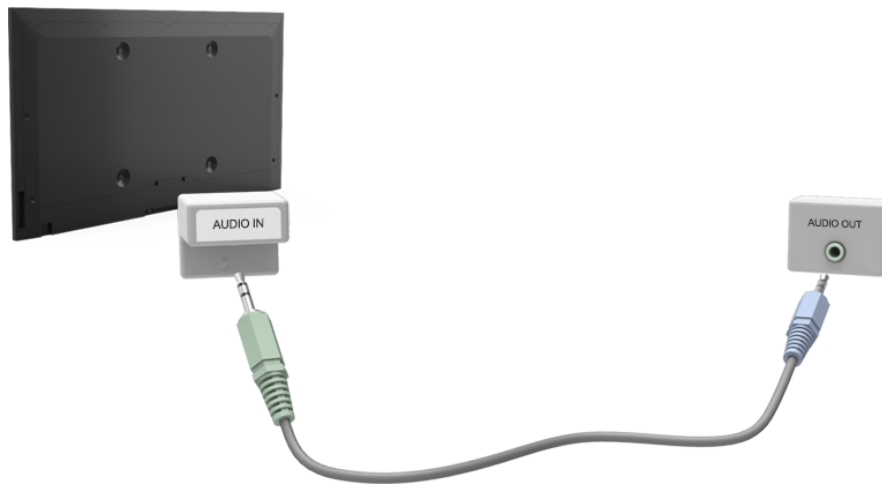

Once the connection has been made, press the **SOURCE** button to select the connected external device.

Connecting to a Computer

You can connect a computer directly to the TV using an HDMI or DVI to HDMI cable and use the TV as a monitor. You can also connect the TV to a computer via your home network and access media files saved on the computer on the TV screen. The kinds of connections you can make are listed below.

To use the TV as a Computer Monitor

- Connect through the HDMI Port using an HDMI cable.

You can connect the computer to the TV using an HDMI cable and display the computer screen on the TV.

- Connect through the HDMI (DVI) port using a DVI to HDMI cable.

You can connect a computer to the TV by connecting the computer's DVI port to the TV's HDMI (DVI) port with a DVI to HDMI cable and display the computer screen on the TV.

To Access Media Files on a Computer and View or Play Them on the TV

- Connect Through Samsung Link.

Quickly access photo, video, and music files saved on a computer on which Samsung Link software is installed, even if you do not connect the TV directly to the computer.

- Connect Through DLNA Using Your Home Network.

Quickly access photo, video, and music files saved on a computer by connecting the TV and the computer to the same router or AP.

- Connecting via Samsung Smart View 2.0

By installing and running the Smart View 2.0 on the PC, you can view the TV screen on the PC, or play the multimedia content (videos, photos, and music) saved on the PC. Also, you can enter text on your Smart TV using the keyboard connected to your PC. You can also control the TV from the PC.

Connecting Through the HDMI Port

For an HDMI connection, we recommend one of the following HDMI cable types:

- High-Speed HDMI Cable
- High-Speed HDMI Cable with Ethernet

- ✎ Use an HDMI cable with a thickness of 0.55 inches (14mm) or less. Using a non-certified HDMI cable may result in a blank screen or a connection error.
- ✎ Some HDMI cables and devices may not be compatible with the TV due to different HDMI specifications.
- ✎ This TV does not support HDMI Ethernet Channel. Ethernet is a LAN (Local Area Network) built on coaxial cables standardized by the IEEE.
- ✎ Many computer graphics adaptors do not have HDMI ports, but have DVI ports instead. If your computer graphics adaptor has a DVI port, use a DVI to HDMI cable to connect the computer to the TV. For more information, refer to "Connecting With a DVI to HDMI Cable".

Refer to the diagram and connect an HDMI cable to the computer's HDMI output connector and the TV's HDMI input connector.

- ✎ The number of ports, and their names and locations may vary depending on the model.



Once the connection has been made, press the **SOURCE** button to select the connected external device.

Connecting With a DVI to HDMI Cable

If the graphics adapter of your computer does not support the HDMI interface, connect the computer to the TV with a DVI (Digital Visual Interactive) to HDMI cable. Note that the DVI to HDMI connection is only supported by the HDMI (DVI) port and does not support audio signal transmission. To listen to the computer sound, connect external speakers to the computer's audio output connector.

 For the resolutions supported by the TV, refer to "Read Before Connecting a Computer (Supported Resolutions)".

Refer to the diagram and connect the DVI to HDMI cable to the TV's HDMI (DVI) port and the computer's DVI output port.

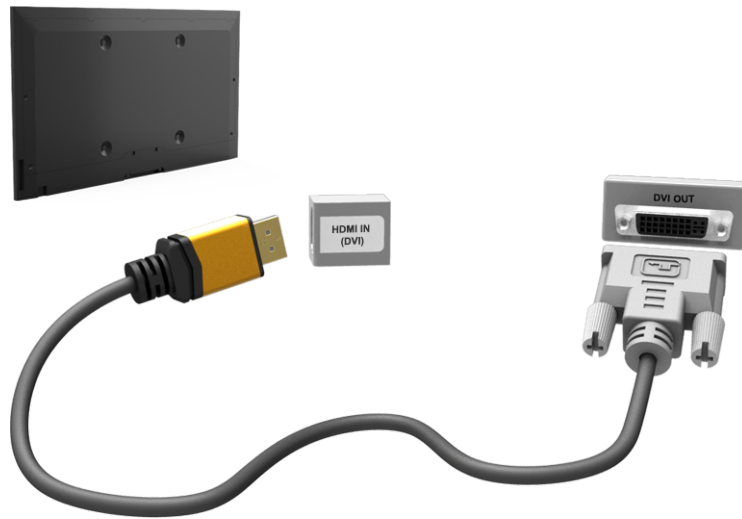

Once the connection has been made, press the **SOURCE** button to select the connected external device.

Connecting Through Samsung Link

Quickly access photo, video, and music files saved on a computer on which Samsung Link software is installed. In addition, using Samsung Link, you can view or play the content of a computer which is registered with Samsung Link through your Samsung account, even if the computer and the TV are not connected to the same router or AP.

1. On a computer, navigate to the Samsung content and service portal (<http://link.samsung.com>), and then sign into your Samsung account.

 To install the Samsung Link desktop software, you need to sign into your Samsung account. If you don't have a Samsung account, create one first.

2. Install the Samsung Link desktop software. When the installation is complete, the computer will be registered with Samsung Link.
3. Specify a folder on the computer to connect to the TV. You can view or play the photo, video, and music files in the specified folder on the TV. For more information about playing or viewing multimedia content, refer to the "Playing Multimedia Content Saved on a Computer/Mobile Device" section.

 For more information about using the Samsung Link desktop software, refer to the Help section of the Samsung Link software.

Connecting Through DLNA Using Your Home Network

Quickly access and play photo, video, and music files stored on a computer on the TV.

1. Connect the TV and the computer to the same router or AP. Once you connect them to the same router or AP, a home network is configured.

 DLNA is the technology that lets TV's, computers, and mobile devices connected to one wired or wireless router share content.

2. On the computer, select [Control Panel] > [Network and Internet] > [Network and Sharing Center] > [Change advanced sharing settings], and then select [Choose media streaming options...] to activate media streaming.

3. From the list, set the TV to [Allowed].

4. Launch Windows Media Player on a computer. Select [Settings] > [Library Management], and then add the location where photo, video, and music files are saved to play them on the TV. For more information about playing content, refer to "Playing Multimedia Content Saved on a Computer/Mobile Device" section.



 Alternatively, you can move the files to the default folder specified by Windows Media Player, and then play or view them on the TV.

 As long as File Sharing is activated, unauthorized access may occur. When you do not need to access data, disable File Sharing.

Connecting via Samsung Smart View 2.0

By installing and running the Smart View 2.0 on the PC, you can view the TV screen on the PC, or play the multimedia content (videos, photos, and music) saved on the PC. Also, you can enter text on your Smart TV using the keyboard connected to your PC. You can also control the TV from the PC.

Download a Smart View 2.0 from the webpage (<http://www.samsung.com/smartview2>) and install it on your PC.

-  Your PC and Smart TV must be connected on the same network.
-  You can access an Install and Connect guide for user for further information. Navigate to [Network Device](#) ([Smart Hub](#) > [MULTIMEDIA](#) > [Network Device](#)) and select [Connect to a Mobile Device](#).

Connecting To a Mobile Device

You can connect a mobile device such as a smartphone or tablet directly to the TV, or connect it to the network and display the mobile device's screen or play its content on the TV. The kinds of connections you can make are listed below.

- **Connect Using an MHL to HDMI cable**

Connect the USB port of the mobile device and the HDMI port of the TV with an MHL to HDMI cable to view the mobile device's screen on the TV screen.

- **Connect by Mirroring the Mobile Device's Screen on the TV (Screen Mirroring)**

Wirelessly connect the TV and the mobile device with the mirroring function. You can view the mobile device's screen on the TV screen.

 This option is available only on a mobile device that supports the mirroring function.

- **Connect Mobile Devices without a Wireless Router (Wi-Fi Direct)**

Wi-Fi Direct enables you to connect the TV and the mobile device without a router or AP. Quickly access and play photo, video, and music files in the connected mobile device on the TV.

 This option is available only on a mobile device that supports the Wi-Fi Direct function.

- **Connect Through Samsung Link**

Samsung Link enables you to play photo, video, and music files saved on a Samsung Link-enabled mobile device easily, without the need for a connection to the TV.

- **Connect Through DLNA Using Your Home Network**



You can conveniently play photo, video, and music files saved on a mobile device by connecting the mobile device and the TV to the same router or AP.

- **Connecting via Samsung Smart View 2.0**

By installing and running the Smart View 2.0 on the mobile device, you can view the TV screen on the mobile device, or play the device's multimedia content (videos, photos, and music) on the TV. Also, you can write texts and control your Smart TV by using the mobile device.

Connecting With an MHL to HDMI Cable

MHL (Mobile High-definition Link) lets you display a mobile device's screen on the TV. However, MHL is only available through the TV's HDMI (MHL) port and only when used in conjunction with an MHL-enabled mobile device. For information on configuring MHL on your mobile device, refer to the device's User Manual.

-  Connecting the MHL-to-HDMI cable automatically switches **Picture Size** to **Screen Fit**. This setting will not change automatically if you are using an HDMI adapter. In this case, change the settings manually in the menu.
-  If you are using an HDMI adapter, the TV recognizes the signal as an HDMI signal and may respond differently than it would to an MHL to HDMI cable connection.

Refer to the diagram and connect the MHL-to-HDMI cable to the TV's HDMI (MHL) port and the mobile device's USB port.

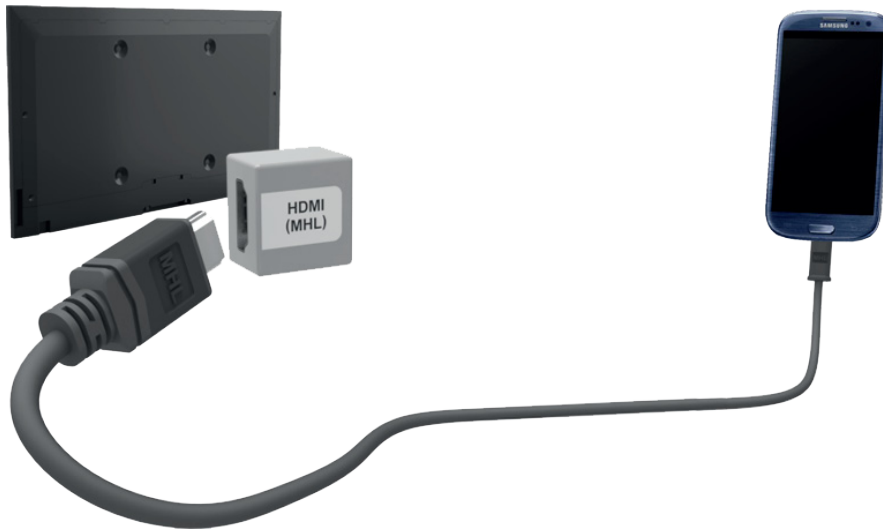

Once the connection has been made, press the **SOURCE** button to select the connected external device.

Screen Mirroring

[MENU](#) > [Network](#) > [Screen Mirroring](#) [Try Now](#)

Wirelessly connect a mirroring-enabled mobile device to the TV and play the video and audio files stored on the device on the TV. Mirroring refers to the function that plays the video and audio files located on a mobile device on a TV and on the mobile device simultaneously.

 To use the Screen Mirroring function, the mobile device must support a mirroring function such as AllShare Cast or Screen Mirroring. To check whether your mobile device supports the mirroring function, please visit the mobile device manufacturer's website.

 The video or audio may intermittently stop depending on network conditions.

Connecting via a mobile device

1. On the mobile device, run [Screen Mirroring](#). The mobile device searches for available devices to connect to.
2. In the search result list, select the TV. The TV displays a pop-up at the top of the screen.
3. In the pop-up, select [Allow](#) to connect the mobile device.

 All previously allowed mobile devices will automatically connect without needing approval.

 If you select [Deny](#), the device cannot connect. In addition, you are setting the device's connection status to Deny and it will not be able to connect in the future unless you change its connection status. To change the connection status of a denied device, Navigate to [Network](#) > [Screen Mirroring](#) > [Device Manager](#), select the device, and then select [Allow](#).

Connecting by Automatically Allowing the Connection

1. Navigate to **Network > Screen Mirroring**, and then select **Screen Mirroring**. The **Screen Mirroring** function starts. You can also start screen mirroring by pressing the **SOURCE** button on your remote, and then selecting **Screen Mirroring** from the list at the top of the screen.
2. Launch Screen Mirroring on your mobile device. The device searches for available devices.
3. Select the TV from the list. The TV automatically allows the connection and the device connects.

 If the mobile device cannot connect, try turning the TV off and on.

Managing the Connection Status of Previously Connected Mobile Devices

-  This function is only available if devices have previously connected to the TV or have previously attempted to connect and been denied.
1. Navigate to **Network > Screen Mirroring > Device Manager**. The TV displays a list of devices that have previously connected to the TV or have tried to connect to the TV and been denied. The status of the connection (Allow/Deny) is also displayed.
 2. Select a device. A pop-up appears.
 3. In the pop-up, you can select Allow connection, Deny connection, or Delete the device from the list.

Connecting Mobile Devices without a Wireless Router (Wi-Fi Direct)

Navigate to [MENU](#) > [Network](#) > [Wi-Fi Direct](#) [Try Now](#)

You can connect a mobile device with the Wi-Fi Direct feature directly to the TV without using a wireless router or AP. By connecting a mobile device to the TV through [Wi-Fi Direct](#), you can play photo, video, and music files saved on the mobile device on the TV.

 This option is available only on a mobile device that supports the Wi-Fi Direct function. Please check if your mobile device supports Wi-Fi Direct.

 The video or audio may intermittently stop depending on network conditions.

1. Enable Wi-Fi Direct on the mobile device, and then navigate to [Network](#) and select [Wi-Fi Direct](#) on the TV. The TV automatically scans for and displays a list of available devices. The TV's name also appears on the mobile device.
2. Select the device from the list to initiate a connection. If a connection request is made by the TV, a permission message appears on the mobile device and vice versa.
3. Allow the connection. The TV and mobile device connect. For more information on the multimedia content, refer to the "Playing Multimedia Content Saved on a Computer/Mobile Device" section.

Connecting Through Samsung Link

Samsung Link lets you play the photo, video, and music files saved on a Samsung Link-enabled mobile device. In addition, using Samsung Link, you can play the content of a mobile device, which is registered to Samsung Link through your Samsung account, even if the mobile device and the TV are not connected to the same router or AP.

1. Run the Samsung Link app on the mobile device, and then sign in to your Samsung account.

 To use Samsung Link, you have to sign in to your Samsung account. If you don't have a Samsung account, create one first.

2. Access and play photo, video, and music files saved on the mobile device. For more information about playing multimedia content, refer to the "Playing Multimedia Content Saved on a Computer/Mobile Device" section.

 For more information about using the Samsung Link mobile software, refer to the Help section of the software.

Connecting Through DLNA Using Your Home Network

Quickly access and play photo, video, and music files stored on a mobile device on the TV.

1. Connect both the TV and the mobile device to the same router or AP. Once you connect them to a single router or AP, a home network is configured.

 DLNA is the technology that lets TV's, computers, and mobile devices connected to one wired or wireless router share content.

2. Enable File Sharing on the mobile device. You can play the content shared on the mobile device on the TV. For more information about playing multimedia content, refer to the "Playing Multimedia Content Saved on a Computer/Mobile Device" section.

 As long as File Sharing is active, unauthorized access can occur. When you do not need to access data, disable File Sharing.

Connecting via Samsung Smart View 2.0

By installing and running the Smart View 2.0 app on the mobile device, you can view the device screen on the TV, or play the device's multimedia content (videos, photos, and music) on the TV. Also, you can send text messages or control your Smart TV by using the mobile device.

Go to SAMSUNG APPS, Google Play and App Store search for and install Smart View 2.0 on your mobile device.

 The mobile device and your Smart TV must be connected with each other in the same network.

 You can access an Install and Connect guide for user for further information. Navigate to [Network Device](#) ([Smart Hub](#) > [MULTIMEDIA](#) > [Network Device](#)) and select [Connect to a Mobile Device](#).

Specifying the Name of the TV on a Network

[MENU](#) > [Network](#) > [Device Name](#) [Try Now](#)

Choose or specify a name for the TV that will appear on mobile devices and laptop computers.

1. Select [Device Name](#) from the [Network](#) menu, and then choose a name from the list that appears. Alternatively, select [User Input](#) to enter a name manually.
2. Check the name from a mobile device or laptop computer.

Switching Between Video Sources

Press the **SOURCE** button to switch between external devices connected to the TV. For example, to switch to a game console connected to the second HDMI connector, press the **SOURCE** button. The **Source List** appears across the top of the screen. From the **Source List**, select **HDMI2**.

 The connector names may vary depending on the product.

Other Functions Available When You Display the Source List

A number of functions are available in the pop-up **Options** menu when the TV displays the Source List. The functions that appear in the **Options** menu vary, depending on the source you selected in the Source List and the external device connected to the source.

To view the **Options** menu, press the **TOOLS** button or press and hold the  button on the standard remote. On the Samsung Smart Control, press and hold the touch pad or press the **KEYPAD** button, and then select **TOOLS** on the On-Screen Remote.

The functions that appear in the **Options** menu can include any of the following:

- **Edit Name:** Lets you assign a device name to an input source, for example, Blu-ray to HDMI1. To assign a device name to an input source, follow these steps:
 1. Open the **Source List**. The list appears in a horizontal line across the top of the TV. Using your remote, highlight the source you want to assign a device name to.
 2. Select **Edit Name** in the **Options** menu. The on-screen keyboard appears.
 3. Using the keyboard, enter a new name. You can enter up to 15 characters.
 4. When finished, select **DONE** on the keyboard, and then press the touch pad or the  button.
- **Information:** View information about the connected devices.
- **Anynet+ (HDMI-CEC):** Displays a list of Anynet+ (HDMI-CEC)-compliant devices that are connected to the TV.

 This option is only available when **Anynet+ (HDMI-CEC)** is set to **On**.

- **Remove USB:** Use to safely remove a USB device connected to the TV. This option is only available when a USB device has been selected.
- **Delete:** Use to delete an external device from a source. When you delete an external device from a source, you erase the information the TV has stored about the device and you delete the association the device has with the source.

The Universal Remote Function

When you display the Source List, the **Universal Remote Setup** button is displayed in the upper right corner of the screen. Select this button to start the Universal Remote function. The Universal Remote function lets you control cable boxes, Blu-ray players, home theaters, and other external devices using your TV remote control. Refer to the "Controlling External Devices with the TV Remote - Using the Universal Remote" section for more information on using the Universal Remote function.

Installing Batteries into the Samsung Smart Control

To use the Samsung Smart Control, insert the batteries into the device referring to the figure below.



1. Gently pull on the notch in the battery cover. When the cover comes loose, remove the cover completely.
2. Insert 2 AA alkaline batteries, making sure to align the positive and negative polarities correctly.
3. Place the battery cover on the remote control, and then press the top part of the cover into the remote control.
4. Press the catches on both sides of the battery cover in the order shown in the figure above until the cover is completely attached to the remote control.

The Low Battery Alarm Window

If the Samsung Smart Control's batteries become low, the Low Battery Alarm appears on the screen. When the Alarm appears, replace the batteries. We recommend using alkaline batteries for longer operating life.





<Low battery Alarm Icon>

Pairing the Samsung Smart Control

To use the Samsung Smart Control with the TV, you must first pair it to the TV via Bluetooth. To pair the Samsung Smart Control to the TV for the first time:

Turn on the TV by pointing the Samsung Smart Control at the remote control sensor of the TV, and then pressing the **TV** button. The TV and Samsung Smart Control pair automatically.

-  The Samsung Smart Control can only connect to one TV at a time.
-  The remote control sensor's location may vary depending on the model.

Reconnecting the Samsung Smart Control

If the Samsung Smart Control stops operating or works abnormally, try replacing the batteries. If the problem persists, pair the Samsung Smart Control and TV again.

1. Move to between 1 foot and 13 feet of the TV (30cm to 4m), and then aim the Samsung Smart Control at the TV's remote control sensor.
 -  The closer you are to the TV the better.
2. Press the **RETURN** and **GUIDE** buttons simultaneously for 3 seconds or more.
3. The Connection in Progress icon appears on the screen. A few moments later, the Connected icon appears. The Samsung Smart Control is paired to the TV.

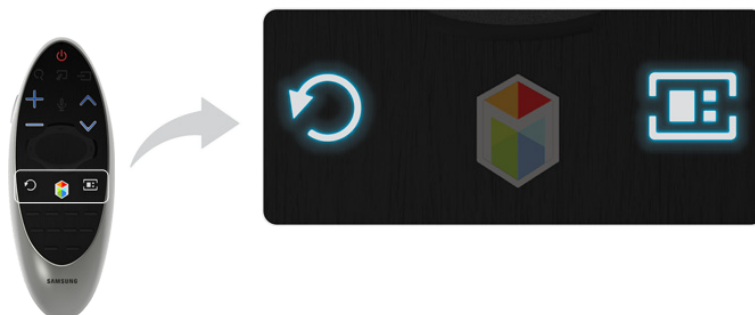

Using the Samsung Smart Control

The Samsung Smart Control makes it easier and more convenient to use the TV. Unlike conventional remote controls that feature buttons only, the Samsung Smart Control has a motion sensor (gyro sensor) that allows you to control the TV easily by holding and moving the Samsung Smart Control. If you press the **KEYPAD** button, an On-Screen Remote appears on the screen that allows you to enter numbers, control content, and use functions easily.



 We recommend using the Samsung Smart Control at a distance of less than 20 feet (6m). The usable distance may vary depending on the wireless environmental conditions.



Button Functions



 Your Samsung Smart Control may differ from the image above, depending on the model.





 Some buttons may differ depending on the country or model.

Button	Description
TV	Turns the TV on and off.
SEARCH	Press this button to search for information through the search window available in various services.
KEYPAD	Displays the On-Screen Remote. With the On-Screen Remote on the screen, you can easily enter numbers, control content, and use functions. For more information, refer to the "Displaying and Using the On-Screen Remote" section.
SOURCE	Changes the source.
VOL	Changes the volume.
VOICE	Starts voice recognition. When the microphone icon appears on the screen, speak a voice command into the microphone. Say "Help" to learn about basic usage and voice commands.  Say a voice command 4 to 6 inches (10 to 15cm) from the microphone at an appropriate volume.
	Turns the sound off and on.
CH	Changes the channel.
▲, ▼, ◀, ▶	Moves the pointer or focus.
Touch pad	Place a finger on the touch pad and move the Samsung Smart Control. The pointer on the screen moves in the same direction. Press the touch pad to select or run the focused item. For more information, refer to the "Using the Touch Pad and the Directional Buttons" section.
◀, ▶, ⏮, ⏭	Controls video, photo, or music file playback on the TV. You can also use these buttons to control the playback of content on an external device (for example, a Blu-ray player).
A, B, C, D	Use these colored buttons to access additional options specific to the feature in use.  This buttons are not available in the U.S.A. and Canada.
RETURN	Returns to the previous menu. Additionally, when you press this button while watching TV, you can return to the previous channel.
SMART HUB	Launches Smart Hub's First Screen. From this panel, you can search through favorite apps, channels, or sources and quickly access previously run or frequently used functions. You can also use services provided on each Smart Hub panel.
GUIDE	Displays the digital channel broadcasting schedule. For more information, refer to the "Digital Broadcast Information at a Glance" section.

Button	Description
3D	Turns the 3D function on or off.
MTS	Press to choose stereo, mono, or Separate Audio Program (SAP broadcast).
CC	Displays captions. Controls the caption decoder.
P.SIZE	Lets you choose the picture size.
MENU	Displays the menu on the screen.
	Enables/Disables Soccer Mode . For more information, refer to the "Making Sports Programs More Realistic with Soccer Mode" section.  This functions is not available in the U.S.A and Canada.
M.SCREEN	Lets you split the TV screen and use multiple functions - such as watching TV, surfing the web, and playing a video - at the same time. For more information, refer to "Using Multiple Functions on a Single Screen (Multi-Link Screen)".

Additional Functions

Press and hold the following buttons for 1 second to use additional functions.



Button	Description
Touch pad	When you use the on screen keyboard, press and hold the touch pad instead of selecting the DONE button to finish entering characters and return to the previous screen.
RETURN (EXIT)	Press and hold the RETURN button to exit all currently running applications
GUIDE (CH.LIST)	Press and hold to launch the Channel List .
B (MENU)	Press and hold to display a menu on the screen.  This buttons are not available in the U.S.A. and Canada.
C (REC)	Press and hold to record the broadcast.  This buttons are not available in the U.S.A. and Canada.
D (INFO)	Press and hold to view information about the current digital channel or media file.  This buttons are not available in the U.S.A. and Canada.
	Press and hold to turn on or turn off the Voice Guide, Video Description, Caption, High Contrast, and Enlarge functions.  Availability depends on your specific area.

Operating the TV by Moving the Samsung Smart Control

The Samsung Smart Control has a motion sensor (gyro sensor) that lets you control the TV easily by moving the Samsung Smart Control and using it much like a cordless mouse.

Place a finger on the Samsung Smart Control's touch pad. A pointer appears on the screen. Move the Samsung Smart Control, and pointer moves on the screen in the direction you moved the Samsung Smart Control and the same distance. Highlight an item on the screen with the pointer, and then press the touch pad to select it.

You can also move the Samsung Smart Control in the same fashion to scroll scrollable screens up and down.

-  When you remove your finger from the touch pad, the pointer disappears.
-  Navigate to **System** > **Smart Control Settings**, and select **Motion Sensitivity** to adjust the pointer speed. **Try Now**
-  If **Voice Guide** is set to **On**, the Samsung Smart Control's motion sensor does not work. For the motion sensor in the Samsung Smart Control to work, you must set **Voice Guide** to **Off**.

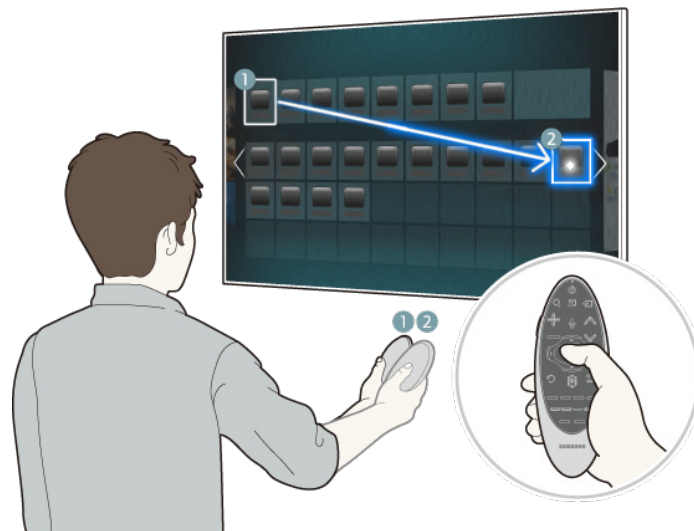

Using the Touch Pad and the Directional Buttons

The touch pad and directional buttons on the Samsung Smart Control let you select and launch items and move the cursor, focus, or panels on the screen.

 In the TV's menu, navigate to **Support** > **Smart Control Tutorial** to view a tutorial that shows how to use the touch pad. [Try Now](#)

If the touch pad's sensitivity is too high or low, navigate to the **System** > **Smart Control Settings** menu, and then select the **Touch Sensitivity** option to change the touch pad sensitivity. [Try Now](#)

Moving the Focus or Pointer



Press the directional buttons (up, down, left, and right) to move the focus, pointer, or cursor in the direction you want.

Entering a Menu / Selecting an Item

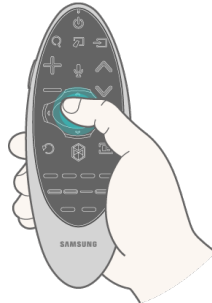

To enter a menu or select an item, highlight the item or the menu title, or move the pointer over it, and then press the touch pad.

Loading the CH List



Press and hold the touch pad while watching TV. To launch the **CH List**.

Displaying a Context-sensitive Menu in Smart Hub



In Smart Hub, highlight an item, and then press and hold the touch pad. The context-sensitive menu for the item pops up.

 The context-sensitive menu may vary depending on the item you selected.

Changing the Smart Hub Panel

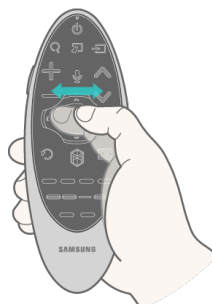

On the Smart Hub screen, drag left or right on the touch pad to display the previous or next panel.

Scrolling on the Web Browser



<Scrolling up or down>

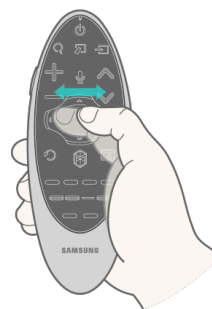

<Scrolling left or right>





Drag up/down or left/right on the touch pad in the web browser to scroll the browser screen.



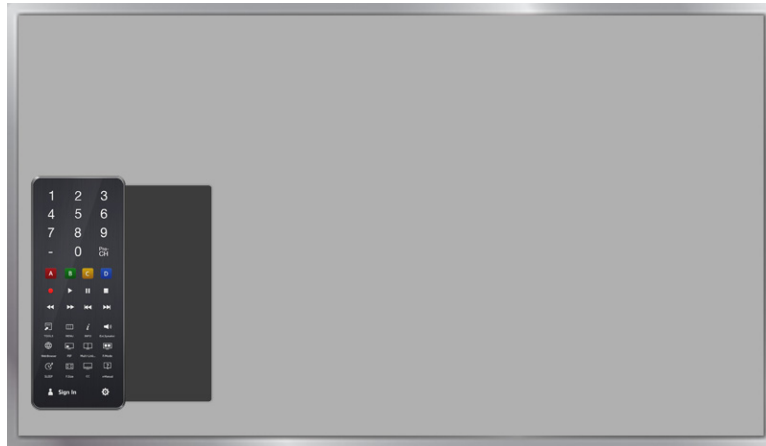



Displaying and Using the On-Screen Remote

Press the **KEYPAD** button on the Samsung Smart Control to display the On-Screen Remote on the TV's screen. Use the On-Screen Remote to enter numbers, control content playback, and use the features and functions of the TV, just like a real remote.

 The On-Screen Remote buttons may vary depending on the TV features or functions you are using.





Button	Description
	<p>Lets you switch channels by entering channel numbers directly. Select Pre-CH to return to the previous channel.</p>
	<p>Controls the playback of video, photo, or music files from all sources, and the playback of media content on external devices (for example, a Blu-ray player).</p>
	<p>Use these colored buttons to access additional options specific to the feature in use.  This buttons are only available in the U.S.A. and Canada.</p>
<p>TOOLS</p>	<p>Press to display the Tools menu while you are watching TV. The Tools menu gives you easy access to frequently used functions. The functions listed are context-sensitive and vary depending on how you are currently using the TV.</p>
<p>INFO</p>	<p>Shows information about the current digital broadcast program or content.</p>

Button	Description
MENU	Displays the TV's menu on the screen.
Speaker Settings	Lets you select the speakers which will play the TV's audio. You must connect a home theater or amplifier with external speakers to the TV to use this function.
PIP	Lets you display video from an external device or computer on the main screen and a TV broadcast in a picture-in-picture window.
Multi-Link Screen	Lets you split the TV screen and use multiple functions - such as watching TV, surfing the web, and playing a video - at the same time.
3D	Turns the 3D function on or off.
MTS	Press to choose stereo, mono, or Separate Audio Program (SAP broadcast).
CC	Select to turn subtitles on or off.
P.Size	Changes the picture size.
SLEEP	This function automatically shuts off the TV after a preset period of time.  Availability depends on the specific model and area.
P.Mode	Lets you select the Picture Mode.  Availability depends on the specific model and area.
Web Browser	Launches the Web Browser.
e-Manual	Opens the e-manual.
Sign In	Select to log in to or out of your Samsung account.
	<p>Move to the right / Move to the left: Moves the On-Screen Remote on the screen. Large size / Normal size: Resizes the On-Screen Remote on the screen.  Alternatively, navigate to the System > Smart Control Settings menu, and then select and set the Onscreen Remote Size option.</p> <p>Motion Sensitivity: Put a finger on the touch pad and move it to adjust the speed of the pointer on the screen.  Navigate to System > Smart Control Settings, and select Motion Sensitivity to enable this option.</p> <p>Touch Sensitivity: Lets you change the touch pad sensitivity.  Alternatively, navigate to the System > Smart Control Settings menu, and then select and set the Touch Sensitivity option.</p> <p>Universal Remote Setup: Displays the Universal Remote Setup screen. For more information, refer to the "Controlling External Devices with the TV Remote - Using the Universal Remote" section.</p> <p>Cancel: Close the pop-up menu.</p>

Controlling External Devices with the TV Remote - Using the Universal Remote

[MENU](#) > [System](#) > [Universal Remote Setup](#) [Try Now](#)

The universal remote control feature lets you control cable boxes, Blu-ray players, home theaters, and other third-party external devices connected to the TV using the TV's remote control. For each external device you want to control, you must run the universal remote set up process. The first step in the process is connecting the IR extender cable (included) to the TV and positioning the transmitter end in front of the device you want to control.

-  You can also use the Anynet+ (HDMI-CEC) function to operate external Samsung devices with your TV's remote control without any additional setup. Refer to the "Using Anynet+ (HDMI-CEC)" section for more information.
-  Certain external devices connected to the TV may not support the universal remote feature.

Connecting the IR Extender Cable

-  The color and design of the IR extender cable may vary depending on the model.

To begin the universal remote set up process, connect the IR extender cable (included) to the TV's IR output connector as shown in the diagram. Then, position the transmitter end within 4 inches (10 cm) of the external device's remote control sensor, pointing in the direction of the sensor.

There can be no obstacles between the transmitter end of the IR extender cable and the external device. Any obstacles will interfere with the transmission of the remote control signals.

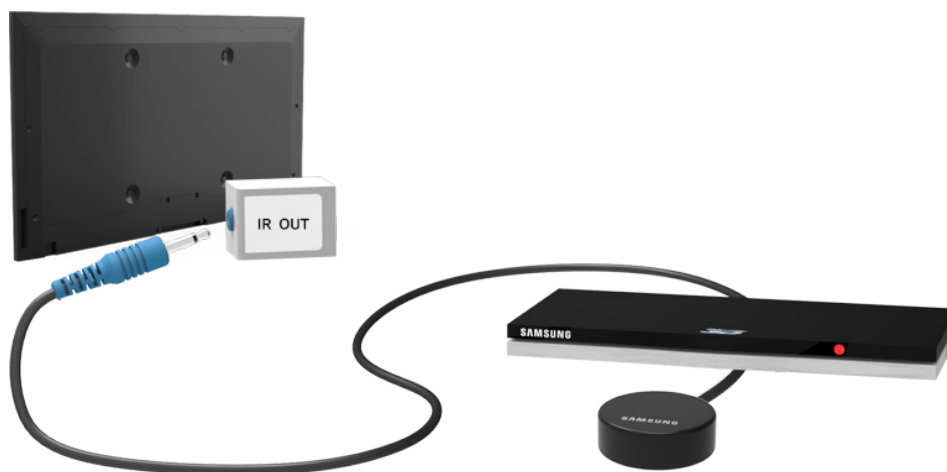

Setting Up the Universal Remote Control

 If you want to control a set-top-box, you need to have your zip code and your cable provider's name and location on hand before you begin. If you want to control a Blu-ray player or home theater, you need the manufacturer's name and the device's model number.

1. Turn on the external device you want to control with the universal remote function.

Important: If you want to control the external device without leaving the IR extender in front of the device, you must use the Samsung Smart Control to set up the Universal Remote function for the device. You must also use the Samsung Smart Control to control the device.

2. Press the **SOURCE** button on your remote to bring up the **Source** screen.

3. Select the  **Universal Remote Setup** icon.

 You can also start Universal Remote Setup through the TV's menu. Navigate to **System > Universal Remote Setup**.

4. The TV checks if the IR Extender cable is connected. If it confirms the connection, press the touch pad. On a standard remote, press the  button.
5. Select the type of device you want to control - set-top-box, Blu-ray player, or home theater.
6. Follow the directions on the screen to complete the set up and register the device. The directions will be different, depending on the device you want to control.

 If the external device does not respond after being registered, register it again using its model number.

7. Once set up is complete and you have confirmed that you can use the TV remote to control the device, disconnect the IR extender cable from the TV and set it aside - if you ran set up using the Samsung Smart Control. You can now control the device directly with the Samsung Smart Control.

 If you are using the Standard remote, you must leave the IR extender in place so that it faces the external device to be able to control the device.

Controlling an External Device with the TV Remote

During the universal remote set up process, the TV registers the connector (source) the external device is connected to. To control a registered external device with your TV's remote, select the external device on the Source List.

1. Press the **SOURCE** button on your remote.
2. Select the source (connector) the device is connected to (HDMI1, HDMI2, etc.). If the external device is a Blu-ray player, home theater, or similar kind of device, the external device's home screen or menu appears on the TV screen. If the external device is a set-top-box, a channel appears on the screen.
3. If you are using the Samsung Smart Control, aim the Samsung Smart Control at the device to control it. If you are using the Standard remote, aim the remote at the IR sensor on the TV to control the device.

Universal Remote Features

1. Press **SOURCE** to display the **Source** list.
2. Select  **Universal Remote Setup** from the top of the screen. This initiates the universal remote setup process.
3. Select an external registered device on the **Universal Remote Setup** screen. The following options are available:

- **Use with Home Theater**

Listen to the audio from an external device through the connected home theater.



This is available only if you have selected a set-top-box or Blu-ray player in Step 3 and you have a home theater connected to the TV.

- **Use with Set-Top Box**

Listen to the audio from a set-top box through the home theater that is connected to the TV.



This is available only if you have selected a set-top-box in Step 3 and you have a home theater connected to the TV.

- **Use with Blu-ray player**

Listen to the audio from a Blu-ray player through the home theater that is connected to the TV.



This is available only if you have selected a Blu-ray player in Step 3 and you have a home theater connected to the TV.

- **Source Setup**

Change the TV's input source of your selected external device.

- **Synced TV power**

When set to On, the connected set-top-box turns off when you turn the TV off.



This is available only if you have selected a set-top-box in Step 3. You can only sync TV power to a set-top-box.

- **Rename**

Rename the registered external device. The name can be up to 15 characters long.

- **Delete**

Remove the external device from the list of registered devices. The device is de-registered and you will no longer be able to control it with the Universal Remote function.

Controlling the TV with a Keyboard

[MENU](#) > [System](#) > [Device Manager](#) > [Keyboard Settings](#) [Try Now](#)

Connecting a keyboard makes it easy to control most of the functions on the TV.

 Certain models do not support USB HID class keyboards.

Connecting a Keyboard

Connecting a USB Keyboard

Plug the keyboard cable into the TV's USB port. A connection message appears on the screen.

Connecting a Bluetooth Keyboard [Try Now](#)

1. Place the Bluetooth keyboard into standby status.

 Refer to the keyboard manual for information about putting the keyboard into standby status.

2. Select [System](#) > [Device Manager](#) > [Keyboard Settings](#) > [Add Bluetooth Keyboard](#). The [Add Bluetooth Keyboard](#) screen appears and the TV automatically scans for available keyboards.

 If your keyboard was not detected, position the keyboard close to the TV, and then select [Refresh](#). The TV scans for available keyboards again.

3. Select the Bluetooth keyboard from the scan list, and then select [Pair and connect](#). A number appears on the screen.

4. Enter the number using the Bluetooth keyboard. This pairs the Bluetooth keyboard to the TV.

 Select [Yes](#) to change the keyboard's options or [No](#) to leave them as they are. Refer to the "Input Languages, Keyboard Type, and Switch Language Key" section for more information.

Using the Keyboard

Use the following remote features with the USB or Bluetooth keyboard connected to the TV.

- Arrow Keys (moving the focus), Windows Key (**MENU** Button), Menu List Key (**TOOLS** Button), Enter Key (Select/run item), ESC (**RETURN** Button), Number Keys (Number Buttons)
- F1 (**A**), F2 (**B**), F3 (**C**), F4 (**D**), F5 (**E**), F6 (**SOURCE** Button), F7 (**CH List**), F8 (**Cursor** Button), F9/F10 (Volume Buttons), F11 / F12 (Channel Buttons)
- Page Up/Page Down: Scroll web browser pages up/down.

Changing Keyboards [Try Now](#)

Select **System** > **Device Manager** > **Keyboard Settings** > **Select Keyboard**. Designate which keyboard to use.

 Only one keyboard can be used at a time.

Input Languages, Keyboard Type, and Switch Language Key

Select **System** > **Device Manager** > **Keyboard Settings** > **Keyboard Options**. The following options are available: [Try Now](#)

- **Keyboard Language**

If the keyboard supports multiple languages, choose the language you want to use from the displayed list.

- **Keyboard Type**

Match the Keyboard Type to the language selected in **Keyboard Language**.

 The **Keyboard Type** list varies depending on which language was selected under **Keyboard Language**.

- **Switch Input Language**

If the keyboard supports multiple languages, choose the key you want to use to switch between languages.

Controlling the TV with a Mouse

[MENU](#) > [System](#) > [Device Manager](#) > [Mouse Settings](#) [Try Now](#)

Connecting a mouse makes it easy to control most of the functions on the TV.

 Certain models do not support USB HID class mice.

Connecting a Mouse

Connecting a USB Mouse

Plug the mouse cable into the TV's USB port. A connection message appears on the screen.

Connecting a Bluetooth Mouse [Try Now](#)

1. Place the Bluetooth mouse in standby status.

 Refer to the mouse manual for information about putting the mouse into standby status.

2. Select [System](#) > [Device Manager](#) > [Mouse Settings](#) > [Add Bluetooth Mouse](#). The [Add Bluetooth Mouse](#) screen appears and the TV automatically scans for available mice.
3. Select the Bluetooth mouse from the scanned list, and then select [Pair and connect](#). This pairs the Bluetooth mouse to the TV.

Using the Mouse

Once a USB or Bluetooth mouse is connected to the TV, a pointer appears on the TV's screen. You can use this pointer to control the TV in the same way you use a pointer on a computer.

- **Selecting and Running an Item**

Left-click using the mouse.

- **Showing Tools Buttons**

Right-clicking displays the Tools buttons on the screen so that you can easily use the TV's functions.

 The Tools buttons may vary depending on the function your are using.

- **Scrolling the TV Menu or Screen**

Move the mouse wheel up or down. This scrolls the TV menu or screen up/down.

- **Exiting the TV Menu or Feature**

Click the X button. This closes the menu.

 The X button appears on the TV menu when a mouse is being used. Left-clicking once while using a feature displays the X button on the current screen.

Changing Mice [Try Now](#)

Select [System](#) > [Device Manager](#) > [Mouse Settings](#) > [Select Mouse](#). Designate which mouse to use.

 Only one mouse can be used at a time.

Changing Mouse Buttons and Pointer Speed [Try Now](#)

Select [System](#) > [Device Manager](#) > [Mouse Settings](#) > [Mouse Options](#). The following options are available:

- **Primary Button**

Choose which button (left or right) to use to select and run items.

- **Pointer Speed**

Adjust the movement speed of the pointer that appears on the screen.

Entering Text Using the On-Screen QWERTY Keypad

A QWERTY keypad appears when you need to enter text (entering the network password, logging into your Samsung account, etc.), allowing you to enter text using your remote control.

Using Additional Functions

Select  on the QWERTY keyboard screen. The following options are available:

- **Recommended text**

Enable/disable the Recommended Text feature. Enabling the **Recommended text** feature allows you to quickly enter text starting with the characters you typed in by displaying recommended words. To enter the word "Internet," for example, all you have to do is enter "In" and select the word "Internet" from the list of recommended words. The word is memorized so that you can enter the same text again more easily.

- **Reset recommended text data**

Delete both the recommended words and the memorized words to clear the list.

- **Predict Next Letter**

Enable/disable the Text Prediction feature. Enabling the Text Prediction feature eliminates the need to find and select individual character keys. To enter the word "Internet," for example, select "I". A predicted word will then appear next to the I key. Simply select the predicted word to enter "Internet".

 This feature is limited to words that have previously been added to the dictionary.

Establishing a Wired Internet Connection

Connecting the TV to the Internet gives you access to online services and SMART features, and lets you update the TV's software quickly and easily through the Internet.

Using Cat 7 LAN Cables

We recommend using Cat 7 LAN cables to link your TV to the Internet Access Points.

 The TV will not be able to connect to the Internet if the network speed is below 10Mbps.

There are three ways to connect the TV to your Internet Access Points. Using Cat 7 cables, connect the TV to the Access Points as shown in one of the following illustrations.

- External Modem

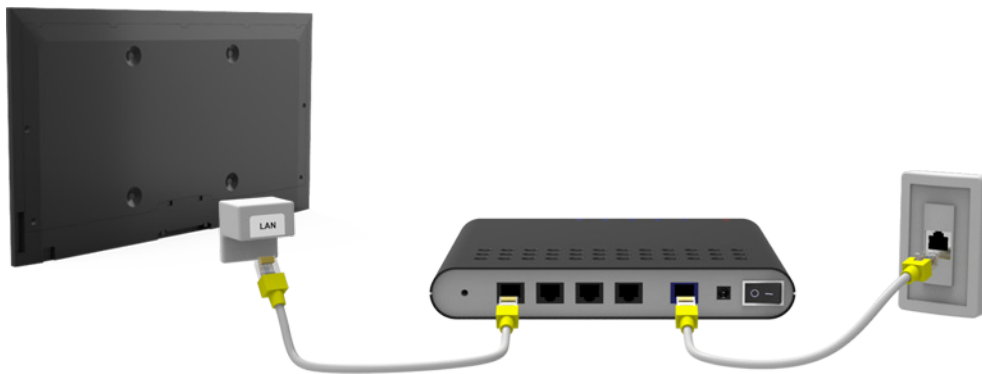

- ① IP Router + ② External Modem

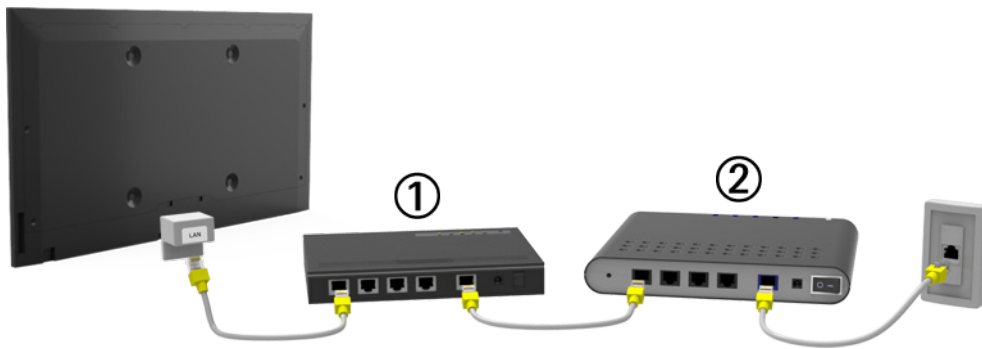

- Wall-mounted LAN Outlet



Connecting to a Wired Internet Network Automatically

[MENU](#) > [Network](#) > [Network Settings](#) [Try Now](#)

Automatically connect to an available network.

1. Set the **Network type** to **Wired**, and then select **Connect**.
2. The TV attempts to connect to an available network. Once it is successful, you will see a confirmation message. Select **OK**. If the attempt fails, try again, or connect manually.

Connecting to a Wired Internet Network Manually

MENU > Network > Network Settings

With networks that require a static IP address, you will need to enter the IP address, subnet mask, gateway, and DNS values manually to connect to the network. To get these values, contact your Internet Service Provider (ISP).

 Refer to the "Dynamic versus Static IP Addresses" section for more information on dynamic IP and static IP addresses.

1. Set the **Network type** to **Wired**, and then select **Connect**.

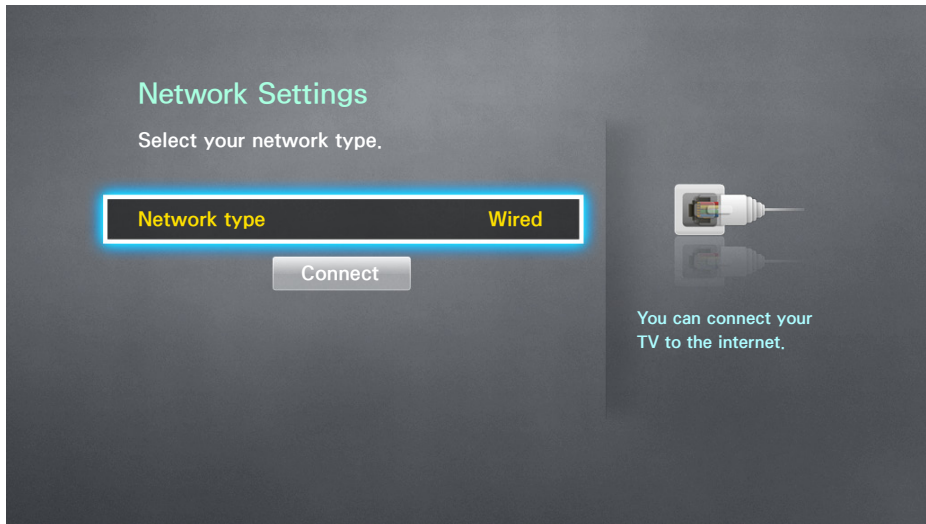

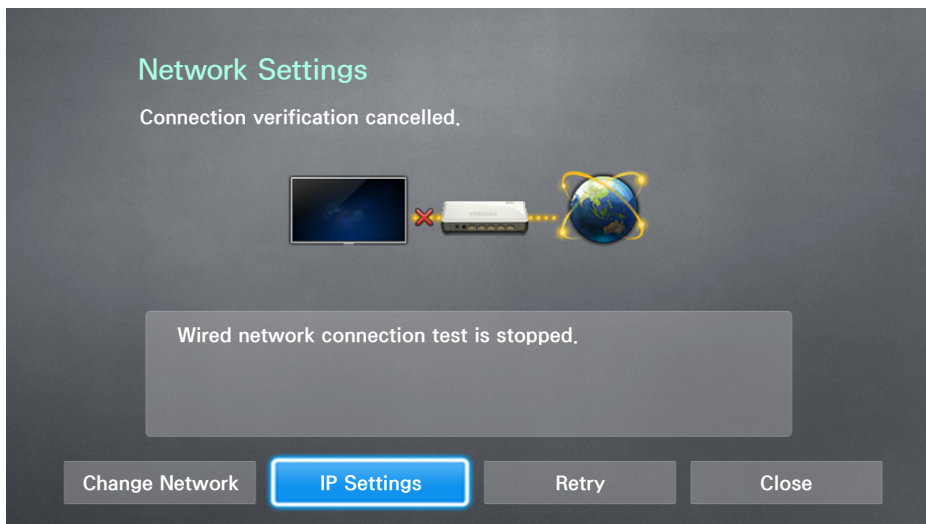

2. Select **Stop** when the TV attempts to connect to the network. Once the network connection has been interrupted, select **IP Settings**.

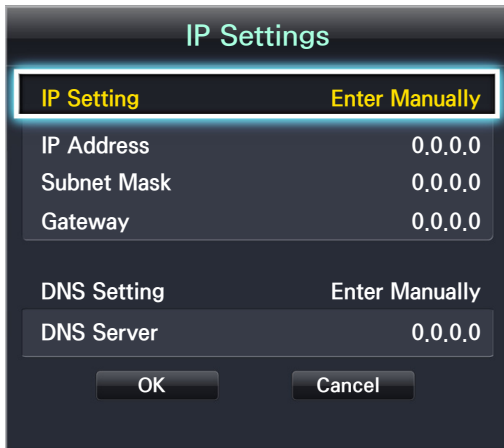

3. In the IP Settings screen, set **IP Setting** to **Enter Manually**.



4. Select **IP Address**. When the IP Address entry window appears, enter three digits into each field on the IP Address line. If the value has less than three digits, add leading zeroes. For example, to enter 10, enter 010. After three digits have been entered in a field, the highlight automatically jumps to the next field.

 On a standard remote, enter numbers by pressing the number buttons. On the Samsung Smart Control, press the **KEYPAD** button. The On-Screen Remote appears. Use the On-Screen Remote to enter numbers. After you have filled in all four fields, press the touch pad on the Samsung Smart Control or the  button on the standard remote again.

5. Repeat the process for **Subnet Mask**, **Gateway**, and **DNS Server**.

6. When done, select **OK**.

7. The TV attempts to connect to the network again using the settings you entered. Once it has established the connection, it displays a confirmation message. Select **OK**.

 The network connection speed may differ depending on the DNS server settings.

 For details on the DNS server settings, contact your Internet service provider (ISP).

Establishing a Wireless Internet Connection

Connecting the TV to the Internet gives you access to online services and SMART features, and lets you update the TV's software quickly and easily through the Internet.



Connecting to a Wireless Internet Network Automatically

MENU > **Network** > **Network Settings**

Connect the TV to the Internet via a wireless router. Make sure you have the wireless router's SSID (name) and password settings before attempting to connect. The password can be found on the wireless router's configuration screen.

1. On the **Network Settings** screen, set **Network type** to **Wireless**. The TV automatically displays a list of available wireless networks.
2. Select a network. If the network you want doesn't appear in the list, select **Add Network**, and enter the network's SSID (name) manually.
3. Using the on-screen keyboard that appears, enter the password. When finished, select **Done**. If the selected network is not security-enabled, the TV will by-pass the on-screen keyboard and attempt to connect right away.
 - To select a character on the on-screen keyboard, highlight the character and then select it. Select **Caps** to view capital letters. Select the **123#&** key to view additional characters.
 - To view the password as you enter it, select **Show Password**.
4. The TV attempts to connect to the network. Once a connection is established, the TV displays a confirmation message. Select **OK**. If the attempt fails, try again or connect manually

Connecting to a Wireless Internet Network Manually

MENU > Network > Network Settings

With networks that require a static IP address, you will need to enter the IP address, subnet mask, gateway, and DNS values manually to connect to the network. To get the IP address, subnet mask, gateway and DNS values, contact your Internet Service Provider (ISP).

- Refer to the "Dynamic versus Static IP Addresses" section for more information on dynamic IP and static IP addresses.
- 1. On the Network Settings screen, set **Network type** to **Wireless**. The TV automatically displays a list of available wireless networks.

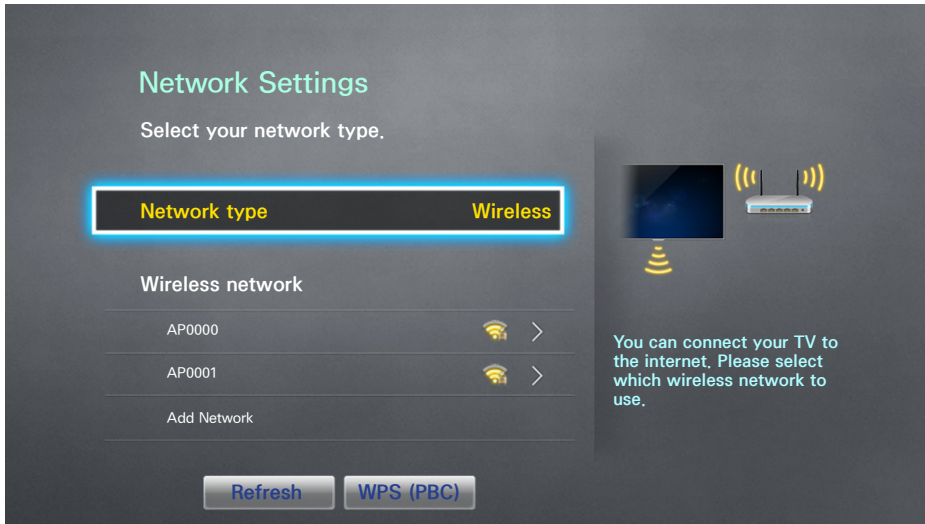

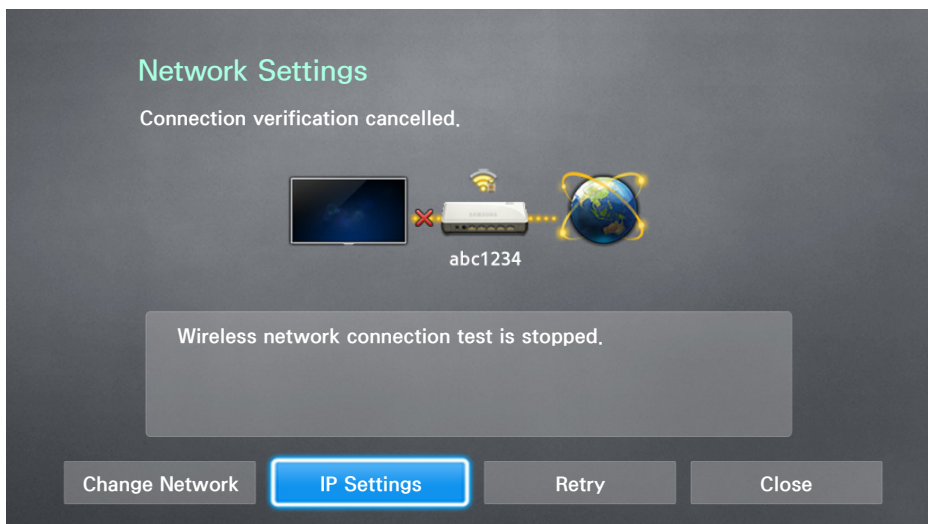

- 2. Select a network. If the network you want doesn't appear in the list, select **Add Network**, and enter the network's SSID (name) manually.
- 3. Using the on-screen keyboard that appears, enter the password. When finished, select **Done**. If the selected network is not security-enabled, the TV will by-pass the on-screen keyboard and attempt to connect right away.
 - To select a character on the on-screen keyboard, highlight the character and then select it. Select Caps to view capital letters. Select the 123#& key to view additional characters.
 - To view the security password as you enter it, select **Show Password**.
- 4. Select **Stop** when the TV attempts to connect to the network. Once the network connection has been interrupted, select **IP Settings**.

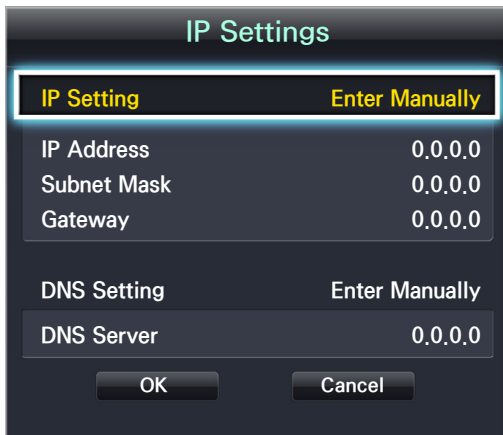

5. In the IP Settings screen, set **IP Setting** to **Enter Manually**.



6. Select **IP Address**. When the IP Address entry window appears, enter three digits into each field on the IP Address line. If the value has less than three digits, add leading zeroes. For example, to enter 10, enter 010. After three digits have been entered in a field, the highlight automatically jumps to the next field.

 On a standard remote, enter numbers by pressing the number buttons. On the Samsung Smart Control, press the **KEYPAD** button. The On-Screen Remote appears. Use the On-Screen Remote to enter numbers. After you have filled in all four fields, press the touch pad on the Samsung Smart Control or the  button on the standard remote again.

7. Repeat the process for **Subnet Mask**, **Gateway**, and **DNS Server**.
8. When done, select **OK**.
9. The TV attempts to connect to the network again using the entered settings. Once it has established the connection, it displays a confirmation message. Select **OK**.

 Network connection speeds may differ depending on the DNS server settings.

 For details on the correct DNS server settings, contact your Internet service provider (ISP).

Connecting to a Wireless Internet Network with WPS

MENU > Network > Network Settings

If the router has a WPS push button, you can use it to connect the TV to the router automatically. WPS automatically configures the SSID and WPA key settings.

- Your router must support WPS to use the WPS functionality.
1. On the **Network Settings** screen, set **Network type** to **Wireless**. The TV automatically displays a list of available wireless networks.
 2. Select **WPS (PBC)**, and then press the router's WPS or PBC button within two minutes.
 3. The TV automatically acquires the SSID and password settings, and then connects to the network. Once a connection is established, the TV displays a connection message. Select **OK**.

Troubleshooting Internet Connectivity Issues

If you are not able to connect the TV to the Internet, read the information below.

Troubleshooting Wired Internet Connectivity Issues

No network cable found [Try Now](#) [Try Now](#)

Make sure the network cable is plugged in. If it is connected, make sure the router is turned on. If it is on, try turning it off and on again.

IP auto setting failed [Try Now](#)

Do the following or configure the [IP Settings](#) manually.

1. Ensure that the DHCP server is enabled on the router and reset the router.
2. If this does not work, contact your Internet Service Provider for more information.

Unable to connect to the network [Try Now](#)

Do the following:

1. Check all [IP Settings](#).
2. Ensure that the DHCP server is enabled on the router. Then, unplug the router and plug it back in.
3. If this does not work, contact your Internet Service Provider for more information.

Connected to a local network, but not to the Internet [Try Now](#)

1. Make sure that the Internet LAN cable is connected to the router's external LAN port.
2. Check the DNS values in [IP Settings](#).
3. If the problem persists, contact your Internet Service Provider.

Network setup is complete, but unable to connect to the Internet [Try Now](#)

If the problem persists, contact your Internet Service Provider.

Troubleshooting Wireless Internet Connectivity Issues

Wireless network connection failed, [Try Now](#) [Try Now](#)

Selected wireless router not found. Go to [Network Settings](#) and select the correct router.

Unable to connect to a wireless router [Try Now](#) [Try Now](#)

Check the following:

1. Check if the router is turned on. If it is, turn it off and on again.
2. Enter the correct password if required.

IP auto setting failed [Try Now](#)

Do the following or configure the [IP Settings](#) manually.

1. Make sure that the DHCP server is enabled on the router. Then, unplug the router and plug it back in.
2. Enter the correct password if required.
3. If this does not work, contact your Internet Service Provider for more information.

Unable to connect to the network [Try Now](#)

Do the following:

1. Check all [IP Settings](#).
2. Enter the correct password if required.
3. If this does not work, contact your Internet Service Provider for more information.

Connected to a local network, but not to the Internet [Try Now](#)

1. Make sure that the Internet LAN cable is connected to the router's external LAN port.
2. Check the DNS values in [IP Settings](#).
3. If the problem persists, contact your Internet Service Provider.

Network setup is complete, but unable to connect to the Internet [Try Now](#)

If the problem persists, contact your Internet Service Provider.

Checking the Internet Connection Status

MENU > Network > Network Status [Try Now](#)

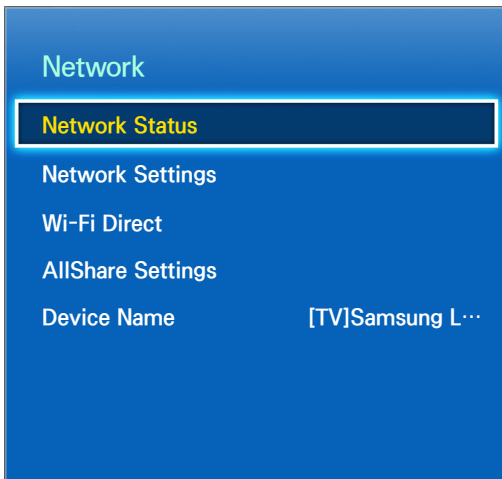



 Your TV's menu may differ from the image above, depending on the model.

View the current network and Internet status.

Using Multiple Functions on a Single Screen (Multi-Link Screen)

MENU > Picture > Open Multi-Link Screen [Try Now](#)



Multi-Link Screen allows you to search the Web, use apps, and much more simultaneously while watching TV.

-  Before using Multi-Link Screen, make sure the TV is connected to the Internet. Using Multi-Link Screen requires an Internet connection.
-  (In the U.S.A and Canada) Before using Smart Hub with Multi-Link Screen, go to **On TV Settings (Smart Hub > On TV Settings > Set Up Service Provider)** and finish configuring Smart Hub if you haven't done so already.
-  (For other countries) If you launch Multi-Link Screen, but have not yet configured Smart Hub, a pop-up window appears. In the pop-up window, select Set Up Smart Hub. You must configure Smart Hub before you can use Multi-Link Screen.

Launching Multi-Link Screen

Press **M.SCREEN** on the Samsung Smart Control to launch Multi-Link Screen.

Using Multi-Link Screen

-  UHD and FHD contents and channels cannot be viewed simultaneously.
-  Launching **Smart Hub** while using Multi-Link Screen automatically terminates Multi-Link Screen.
-  Certain TV features and apps may not be supported by Multi-Link Screen. If this is the case, exit from Multi-Link Screen and then use the feature.

Selecting a Feature

1. Press the Samsung Smart Control's **M.SCREEN** button while Multi-Link Screen is running. The Options menu appears.
2. Select a feature from the Options menu. This initializes the selected feature.









 Features supported by Multi-Link Screen vary depending on your country.

Changing the Channel/Volume

1. Place the pointer or focus over the screen on which you want to change the channel or adjust the volume.
2. Use the channel buttons to change the channel or the volume buttons to adjust the volume.



Pairing Bluetooth Headphones

Pairing Bluetooth headphones to the TV lets you to hear the audio from a different screen through the headphones.

-  Compatibility issues may occur with Mobile headphones, which may not work.
 -  Sync issues may occur, depending on the video and audio and on the devices used.
 -  The headphones and the TV may disconnect, depending on the distance between them.
 -  You can't use Bluetooth headphones, TV SoundConnect and Surround features simultaneously.
 -  When Multi-link Screen is terminated, the Bluetooth headphone is disconnected.
1. Put the Bluetooth headphones in the pairing-ready status.
 -  Refer to the headphones' manual for instructions on enabling the pairing-ready status.
 2. Press the Samsung Smart Control's **M,SCREEN** button while Multi-Link Screen is running. The Options menu appears.
 3. Select **Settings** from the Options menu.
 4. Select **Connect Bluetooth Headphones** from the **Settings** menu. The TV displays the Bluetooth-pairing window, and then automatically scans for available headphones.
 -  If the scan fails to locate your headphones, try placing the headphones closer to the TV, and then select **Refresh**.
 5. Select your headphones from the list of scanned headphones, and then select **Pairing & Connection** to pair the headphones and the TV.
 -  The Bluetooth headphone with a history of pairing is easily reconnected to the TV.
 -  If there arise the headphone compatibility issues, clear pairing device history from the Bluetooth headphone and search again to reconnect.

Selecting the Audio-Source Screen





You can listen to audio from one screen through the speakers and audio from a different screen through the Bluetooth headphones.

1. Press the Samsung Smart Control's **M,SCREEN** button while Multi-Link Screen is running. The Options menu appears.
2. Select **Settings** from the Options.
3. Select **Speaker Settings** from the **Settings** menu.
4. Select a screen for **TV Speaker** and another for **Bluetooth Headphone**.
 -  The same screen cannot be selected for both **TV Speaker** and **Bluetooth Headphone**.
 -  **Auto** is only supported by the TV speaker. Bluetooth headphones are not supported.

Smart Hub

[MENU](#) > [Smart Hub](#) > [Open Smart Hub](#) [Try Now](#)

With Smart Hub, you can surf the web, download apps, and stay in touch with family and friends through social networking services. In addition, you can enjoy photo, video, and music files stored on external storage devices.

-  Smart Hub service outages can be caused by disruptions in your Internet service.
-  Some of the Smart Hub services are for pay services. To use a for pay service, you must have an account with the service provider or a Samsung Apps TV account. Refer to the "Using Smart Hub with a Samsung Account" section for more information.
-  The TV must be connected to the Internet to access Smart Hub.
-  Some Smart Hub features may not be available depending on the service provider, language, or region.
-  To use Smart Hub, you must agree to the end user agreement and privacy policy. Otherwise, you will not be able to access the features and services associated with them. You can view the entire text of the [Terms & Policy](#) by navigating to [Smart Hub](#) > [Terms & Policy](#). If you want to stop using Smart Hub, you can cancel the agreement. [Try Now](#)

Testing Smart Hub connections

[MENU](#) > [Support](#) > [Self Diagnosis](#) > [Smart Hub Connection Test](#)

If Smart Hub is not functioning, navigate to [Support](#) > [Self Diagnosis](#) > [Smart Hub Connection Test](#). Diagnose the problem by checking the internet connection, your ISP, the Samsung server and the Samsung Apps panels.

-  After completing the test, if Smart Hub continues to have problems, contact your Internet Service Provider or a Samsung Contact Center.

Opening the First Screen

Press the  button while watching TV to open the **First Screen**.

On the **First Screen**, search through favorite apps, channels or sources and access previously run or frequently used functions.

 You can configure the TV to automatically open the **First Screen** when it turns on. Navigate to **Smart Hub > First Screen Settings**, and set **Auto Start** to **On**.

Setting your favorite item

1. Press the  button to open the **First Screen**, and move to a desired item.
2. Tap and hold the touch pad. The Options menu appears.
3. In the Options menu, select **Add to Favorites** to add the selected item to the favorite list, which will move top of the list.

 To delete a favorite item, select it and tap and hold the touch pad to display the context menu. Then, select **Remove from Favorites**.

Deleting browsing history

1. Press the  button to open the **First Screen**, and select **Clear All**. You will be asked to confirm your selection.
2. Select **OK** on the screen. Your browsing history is deleted completely.

 However, the Favorites list items will not be deleted.

 You can also delete your browsing history by selecting **Clear All** in the **Smart Hub > First Screen Settings** menu.

Moving to the Panel Screen

Press the  button to open the **First Screen**, and select the Panel icon. On the Panel screen for each service panel, the following are available:

-  **Games**

This function is only available in the U.S.A. and Canada.

Navigate to **Smart Hub > Games** to confirm the optimizing game apps for Smart TV and detailed information on Smart hub. This makes it easier to download and play games. In addition, you can manage games that you have downloaded or purchased with your Samsung account.

-  **SAMSUNG APPS**

You can enjoy variety of free and for pay news, sports, weather, and gaming apps on the TV as you would on a smart phone or tablet.

-  **On TV**

This function is only available in the U.S.A. and Canada.

You can view the current programs on TV at a glance and view Program Recommendations by Channel or by Time for programs that will be broadcast later. In addition, you can watch recorded videos.

-  **MOVIES & TV SHOWS**

This function is only available in the U.S.A. and Canada.

You can buy or rent movies and TV shows online and stream them to your TV using apps downloaded via Smart Hub.

-  **MULTIMEDIA**

You can play back photo, video, and music files from an external storage device or watch recorded videos.

-  **NewsON**

This function is not available in the U.S.A. and Canada.

NewsON provides real-world news and weather information all in one place - no need for a newspaper, smartphone, or computer.

-  **SOCCER**

This function is not available in the U.S.A. and Canada.

The **SOCCER** panel offers a variety of information about world soccer matches, featuring videos, news, matchups, and ratings.

Using the Smart Hub Tutorial

[MENU](#) > [Support](#) > [Smart Hub Tutorial](#)

Select [Support](#) > [Smart Hub Tutorial](#). This will familiarize yourself with the basics of Smart Hub and panels.

Resetting Smart Hub

[MENU](#) > [Smart Hub](#) > [Smart Hub Reset](#)

It is possible to remove Samsung accounts and everything linked to them, including apps, from the TV. Enter the password when accessing this menu.

To use Smart Hub fully again after resetting it, users are required to agree to the terms of conditions. Open the [System](#) menu, choose [Setup](#), and then follow the initial setup process.

Using Smart Hub with a Samsung Account

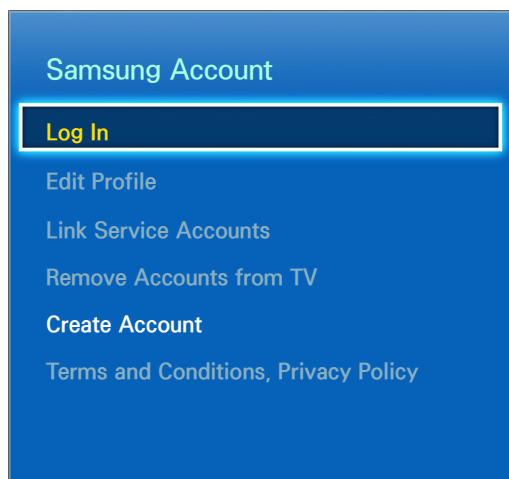



 Your TV's menu may differ from the image above, depending on the model.

Creating a Samsung Account









[MENU](#) > [Smart Hub](#) > [Samsung Account](#) [Try Now](#)

Some of the Smart Hub services are for pay services. To use a for pay service, you must have an account with the service provider or a Samsung Apps TV account (a Samsung account).

You can create a Samsung account using your email address as your ID.



-  To create a Samsung account, you must be over 14 years old.
-  To create a Samsung account, you must agree to the Samsung account end user agreement and privacy policy. Otherwise, you cannot create a Samsung account. You can view the entire content of the agreement by navigating to [Smart Hub](#) > [Samsung Account](#) > [Terms and Conditions, Privacy Policy](#).
-  You can also create a Samsung account at <http://content.samsung.com>. Once you have an account, you can use the same ID on both the TV and the Samsung website.

Creating a Samsung Account Using the Create Samsung Account Menu

1. Press the **MENU** button on your remote, and then select **Smart Hub > Samsung Account > Create Account > Create Samsung Account**. The Terms and Conditions screen appears.
2. On the Samsung Smart Control, press the touch pad to agree to the Terms and Conditions, and then press the touch pad again. On a standard remote, press the  button to agree, and then press  again.
 -  If you want to review the Terms and Conditions, select the View Details buttons.
3. Select the Email field. The keyboard pop-up appears. Enter your e-mail address. On the Samsung Smart Control use the directional buttons to move from character to character, or use the Motion Sensor pointer. Press the touch pad to select a character. Select the **Caps** button on the left to enter capital letters. Select the 123#& button to view and select additional symbols. Select **.com** at the bottom of the keyboard to enter the .com button. On a standard remote, use the directional keys to move from character to character and press the  button to select a character.
4. When finished, select **Done** on the keyboard. The **Create Account** screen reappears.
5. Enter a password, your first name, and last name in the same fashion.
 -  If you want your account to be password protected, select "Password (Security: High)" in the field below the Password field. If you don't, select "No password required". You still need to create a password, however. Other functions in your account require that you enter a password.
 -  Leave "Sign me in automatically" checked if you want the TV to log you in to your account automatically when you turn the TV on.
6. Select the Date of Birth field, and then select numbers pressing the up or down directional buttons, or, on a standard remote, using the number pad. Move from month to day to year by pressing the left or right directional buttons. Press the **RETURN** button on the remote when done.
7. After you have finished with all the fields, select **Next**. The Image Selection screen appears.
8. Select an image to use to identify your account. The Account Created screen appears. Press the touch pad or press the  button. You are signed in to your Samsung account.
 -  If you have an existing account saved on the TV, you must be logged out of the account to create new accounts on the TV.

Creating a Samsung Account using a Facebook Account

If you have a Facebook account, you can use the account to create a Samsung account.

1. Press the **MENU** button on your remote, select **Smart Hub** > **Samsung Account**. And then select **Log In**. The Sign In screen appears.
2. Select , and then select **Create with Facebook** on the Sign In screen.
3. Enter your Facebook ID and password and select **Sign In**.
4. The Terms and Conditions screen appears.
5. On the Samsung Smart Control press the touch pad to agree to the Terms and Conditions, and then press the touch pad again. On a standard remote, press the  button to agree, and then press the  button again.
6. Follow the directions on the Create Account screen to create a Samsung account.
7. Once a Samsung account is created, you are automatically signed in.

 If you create a Samsung account using your Facebook account, they are automatically linked.

Signing in to a Samsung Account

MENU > **Smart Hub** > **Samsung Account** > **Log In**

1. Press the **MENU** button on your remote, and then select **Smart Hub** > **Samsung Account** > **Log In**.
2. On the Log In screen, select your account. And then select **Sign In** on the Sign In screen.
3. If you don't need to enter a password, login proceeds. If you need to enter a password, the on-screen keyboard appears. Enter your password. When finished, select **Done**.

Linking Your Samsung Account to External Service Accounts

[MENU](#) > [Smart Hub](#) > [Samsung Account](#) > [Link Service Accounts](#)

Linking your Samsung account to an external service accounts lets you automatically log in to the linked account when you log into your Samsung account. For example, you can download the Facebook application - which lets you access Facebook from your TV - and then link your Facebook account to your Samsung account. Logging into your Samsung account then automatically logs you into your Facebook account as well and lets you access it directly from the TV.

 To use [Link Service Accounts](#), you must first log into your Samsung account.

Linking a Service Account

1. Log in to your Samsung Account.
2. Navigate to [Smart Hub](#) > [Samsung Account](#), and then select [Link Service Accounts](#). The accounts you can link to your Samsung account are displayed.
3. Select an account from the list. The Link to other accounts window appears on the screen.
4. Enter the current ID and password of the account to log in and select [OK](#).
5. When the login is complete, the account is linked to the Samsung account.

Disconnecting a Linked Account

1. Navigate to [Smart Hub](#) > [Samsung Account](#), select [Link Service Accounts](#). Select an account to unlink.
2. A confirmation dialog box appears. Select [Yes](#) to unlink the account.

Changing and Adding Information to a Samsung Account

[MENU](#) > [Smart Hub](#) > [Samsung Account](#)

Using the Samsung Account menu, you can manage your Samsung account.

 To change the account information, you must be logged in to your Samsung account.

1. Navigate to [Smart Hub](#) > [Samsung Account](#), and then select [Edit Profile](#). The keyboard appears.
2. Enter your password, and then select [Done](#). The Edit Profile screen appears.

The Edit Profile screen lets you do the following:

- **Change Your Profile Image**

Select [Edit Profile Picture](#) to change your profile image.

- **Register Your Face to your Samsung Account**

Select [Register Face](#) to register your face to your Samsung account. The registered face is used by the [Face recognition](#) Sign-in method.

 To use this function, you must connect a TV camera (sold separately) to your TV.

- **Choose a Samsung Account Sign-in Method**

Select [Sign-in Method](#) and choose a sign-in method from the drop down that appears.

- **Turn Auto Login On or Off**

Select [Sign me in automatically](#). Auto Login automatically logs you in to your Samsung account when you turn the TV on. A check mark indicates that Auto Login is on.

- **Enter Basic User Information**

You can enter your first name, last name, and date of birth.

- **Add a Credit Card to Your Samsung Account**

Select [Add Card](#) to add a credit card to your Samsung Account. Adding a credit card to your account makes it easier to purchase online movies and TV shows. Follow the easy directions on the screen.

- **Subscribe to the Samsung e-Newsletter**

You can receive emails containing information about Samsung products, new service announcements, special offers, and events.

Deleting a Samsung Account from the TV

[MENU](#) > [Smart Hub](#) > [Samsung Account](#) > [Remove Accounts from TV](#)

Navigate to [Smart Hub](#) > [Samsung Account](#) and select [Remove Accounts from TV](#). The account and password information for the currently signed in account is deleted from the TV. The account information for any external accounts linked to the signed in account is also deleted from the TV.

 Only the information for the current signed in account is deleted. Account information for all other accounts saved on the TV remain.

Using the Games Panel

This function is only available in the U.S.A. and Canada.

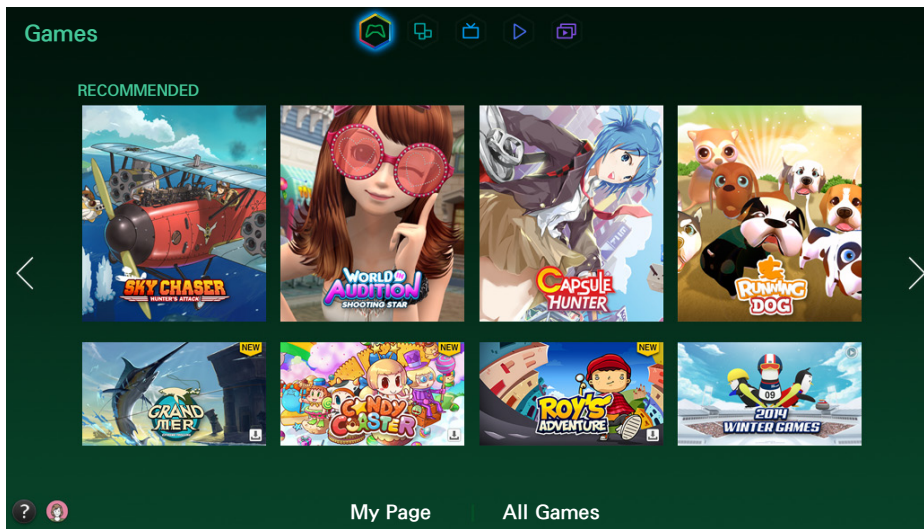

 Usability depends on your specific model and local region.

Navigate to [Smart Hub](#) > [Games](#) to confirm the optimizing game apps for Smart TV and detailed information on Smart hub. This makes it easier to download and play games. In addition, you can manage games that you have downloaded or purchased with your Samsung account.

 The TV must be connected to the Internet for you to use the [Games](#) Panel.

 To purchase or remove games on the [Games](#) panel, you must be logged in to your Samsung Account.

Using Supported Features via the Pop-Up Menu

On the [My Page](#) or [All Games](#) panel, move the focus to a desired game, and then press and hold the touch pad. On a standard remote, press and hold the  button. A drop down list appears with the following functions.

- **Download/Remove**





Downloads games to the TV or removes games from the TV.

- **View detail**





Displays detailed information for the selected game.

Installing and Running a Game

Quickly Installing Games

1. On the **Games** panel, select **All Games** and select a game from the list, then press and hold the touch pad or the  button. The Options drop down list appears.
 -  On the **All Games** screen, select the  button. The screen will display only games that are compatible with the controller you chose.
 -  On the **All Games** screen, select the  button, and then select a sorting criteria. The games are sorted according to the criteria.
2. In the pop-up list, select **Download**. If you are on the Information screen, select **Download**.
3. If the game is free, the game you selected is installed on the TV. If the game is not free, follow the directions on the screen to pay for and download the game.
 - You can stop a game download by selecting the Cancel button.
 - When the TV's internal memory is insufficient, you can install a game on a USB device.
 - You can play a game installed on a USB device only when the USB device is connected to the TV. If the USB device is disconnected during game playing, the game is terminated.
 - You can play the game installed on the USB device on a PC or another TV.

Installing a Game from the Detailed Game Information Screen





1. On the **Games** panel screen, select a game you want to install. If you cannot find a desired game, select **All Games**.
 -  On the **All Games** screen, select the  button on the top right of the screen. The screen displays only games that are compatible with the controller you chose.
 -  On the **All Games** screen, select the  button in the upper right side of the screen, and then select a sorting criteria. The games are sorted according to the criteria you selected.
2. The Information screen for that game appears displaying information about the game and images and a video from the game. Select the **Download** button to download the game.
3. If the game is free, the game you selected is installed on the TV. If the game is not free, follow the directions on the screen to pay for and download the game.

Launching a Game

To run an installed game, select **Play** on the game's detailed game information screen.



Managing Downloaded or Purchased Games

In Smart Hub, move to the **Games** panel and select **My Page** at the bottom of the screen.



-  On the **My Page** screen, select the  button on the top right of the screen. The screen displays only games that are compatible with the controller you chose.
-  On the **My Page** screen, select the  button in the upper right side of the screen, and then select a sorting criteria. The games are sorted according to the criteria you selected.

Updating a Game

Select **Update Game** at top of the **My Page** screen to update games installed on the TV.

-  **Update Game** appears only when there is a game that needs to be updated.
-  To update games automatically, select the  button at the top of **My Page**, and then set **Auto Update Games** to **On**. Games will now be updated automatically when an update becomes available.

Removing a Game

1. Press the  button at top of the **My Page** screen, and then select **Delete**.
2. Select a game you want to remove by highlighting the game, and then pressing the touch pad or  button. Repeat to select additional games to remove. To select all games, select **Select All**.
3. To deselect a game, highlight it again, and then press the touch pad or  button. When the selection is complete, select **Delete**.

Rating/Sharing/Reviewing a Game

You can rate or share a game through a social network service or send a review to the developer on the detailed information screen.

-  You can rate / share / review a game only if the game has installed on the TV.

Using the SAMSUNG APPS Panel

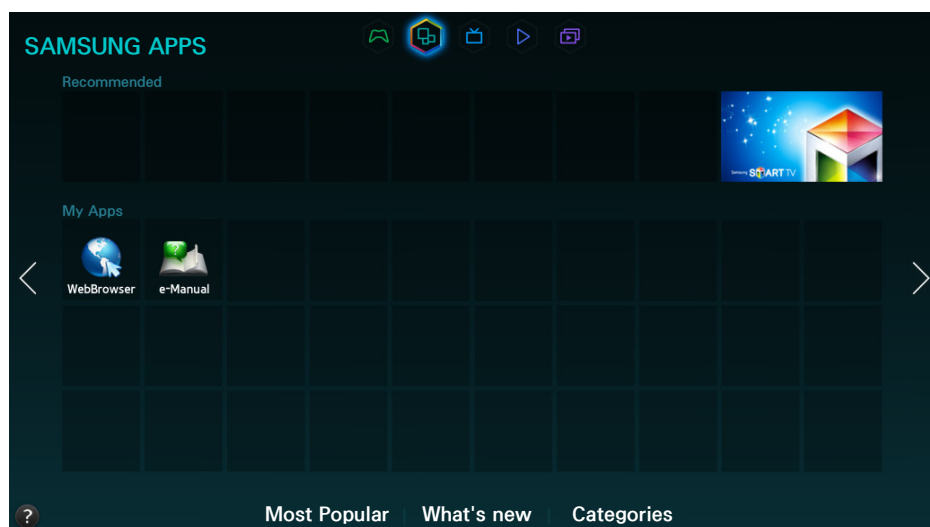

 Usability depends on your specific model and local region.

Smart Hub offers a variety of free news, sports, weather, and gaming apps you can install directly to and enjoy on your TV. The first line on the screen contains apps recommended by Samsung. These apps were automatically downloaded to your TV when you set up Smart Hub. The lines of apps below the first line contain some apps that were automatically downloaded to your TV and other apps you have selected and downloaded.

 Your TV must be connected to the Internet for you to use **SAMSUNG APPS**.

 When Smart Hub is launched for the first time, the default apps are automatically installed. The default apps may differ depending on the region.

Using Supported Features via the Pop-Up Menu - Downloaded Apps

Move the focus to an app in the second row or below, and then press and hold the touch pad. On a standard remote, press and hold the  button. The Tools menu appears displaying the following functions.

- **Move**
Lets you relocate an app on the screen.
- **Delete**
Lets you remove a selected app from your TV.
- **Multi Delete**
Lets you remove multiple apps from the TV.
- **View Details**
Displays detailed information about a selected app.
- **Change View**
Lets you change how the apps are sorted on the screen, by **Custom** or **Most Played**.
- **Lock/Unlock**
Lets you lock or unlock an app.
- **Update Apps**
Displays a list of apps that have updates available. You can select which apps to update.





Using Supported Features via the Pop-Up Menu - Recommended Apps

Move the focus to a recommended app in the top row, and then press and hold the touch pad. On a standard remote, press and hold the  button. A drop down list appears with the following functions.

- **View Details**
Displays detailed information for a selected app.
- **Update Apps**
Lets you update the apps when updates are available.
- **Lock/Unlock**
Lets you lock or unlock an app.

Installing an App

Quick Installation

1. On the **SAMSUNG APPS** screen, select **Most Popular**, **What's new**, or **Categories**.
 -  **Most Popular** and **What's new** show the most popular and new Samsung apps, respectively. To view the entire app list by genre, select **Categories**. When the Categories screen appears, select a category icon to view the apps in that category.
2. Move the focus to an app, and then press and hold the touch pad. On a standard remote, press and hold the  button. A pop-up menu appears.
3. On the pop-up menu, select **Download**.
 -  Most apps are free to install.
 -  While an app is being installed, the progress bar appears so that you can monitor the progress of the installation.
4. The selected app is installed on the TV.
 -  You can view installed apps on the **SAMSUNG APPS** screen.

Installing an App from the Detailed App Information Screen

1. On the **SAMSUNG APPS** screen, select **Most Popular**, **What's new**, or **Categories**.

 The **Most Popular** and **What's new** show the most popular and new Samsung apps, respectively. To view the entire app list by genre, select **Categories**. When the Categories screen appears, select a category icon to view the apps in that category.

2. Select an app from the list. Detailed information about your selection appears on the screen.

3. Select **Download** to install the selected app on the TV.

 Most apps are free to install.

 While an app is being installed, the progress bar appears so that you can monitor the progress of the installation.

4. When the installation is complete, the **Download** button changes to **Open**.

 You can view installed apps on the **SAMSUNG APPS** screen.

Additional Notes

 When the TV's internal memory is insufficient, you can install an app on a USB device.

 You can view icons for the apps saved on the USB device on the Apps screen only when the device is connected to the TV. You can use an app installed on a USB device only when the USB device is connected to the TV. If the USB device is disconnected while the app is running, the app is terminated.





 You can use the app installed on the USB device on a PC or another TV.

Launching an App

Select an app on the **SAMSUNG APPS** screen, and then press the touch pad. On a standard remote, press the  button. You can also start an app from its Detail screen.

App Screen Icons

The icons below appear on the Apps screen and indicate the following:



-  : The app supports motion control.
 -  To use the Motion Control feature, you must install a separately-sold camera on the TV.
-  : The app supports voice control.
-  : The app is installed on a USB device.
-  : The app supports a pointer that can move by the Samsung Smart Control.

Using the e-Manual

Launching the e-Manual

[MENU](#) > [Support](#) > [e-Manual](#)

The embedded e-manual contains information about your TV's key features.

-  Alternatively, you can download a copy of the e-manual from Samsung's website, and read it on your computer or print it out.
 -  Words in yellow (e.g., [Picture Mode](#)) indicate a menu item and bold words in white (e.g., [Smart Hub](#)) indicate remote control buttons.
 -  Arrows are used to indicate the menu path. (Example: [MENU](#) > [Picture](#) > [Picture Mode](#))
1. On the Samsung Smart Control, press the [KEYPAD](#) button, and then select [e-Manual](#) on the On-Screen Remote. On a standard remote, press the [E-MANUAL](#) button. You can also select [Support](#) > [e-Manual](#) in the TV's menu.
 2. Select a category from the left side of the screen. Once a selection has been made, the contents of the selected category appears on the right side of the screen.
 3. Select an item from the list. This opens the e-manual on the corresponding page.

If a description doesn't fit on a single screen...

- Position the focus on the page to display  /  on the screen. Press the  or  buttons to scroll the page up and down.

Additional e-Manual Features

Loading Pages using Keywords

Select [Search](#) to bring up the search screen. Enter a search term, and then select [Done](#). Select an item from the search results to load the corresponding page.

Loading Pages from the Index Page

Select [Index](#) to bring up the index screen. Select a topic from the list to navigate to the relevant page.

Using History to Load Previously Read Pages

Select **Opened page**. A list of previously read pages is shown. Select a page. The e-Manual jumps to the selected page.

Accessing the Menu from the e-Manual

Select  (Try Now) from the right side of a feature-description page to access the corresponding menu item and try out the feature right away. If you want to read the e-Manual entry on a specific screen menu feature:

- On the Samsung Smart Control, press the **KEYPAD** button, and then select **e-Manual** on the On-Screen Remote. To load the corresponding e-Manual page.
- On a standard remote, press the **e-Manual** button.



 The e-Manual cannot be accessed from some menu screens.

Loading Reference Pages

Select  (Link) from the right side of a feature-description page to access the corresponding reference page.

Updating the e-Manual to the Latest Version

You can update the e-Manual in the same way you update apps.

1. Press the  button, and then highlight the **e-Manual** item in the **SAMSUNG APPS** screen.
2. On the Samsung Smart Control, press and hold the touch pad. On a standard remote, press and hold the  button. The Tools menu appears.
3. Select **Update Apps** from the Tools menu. A popup window appears.
4. Select **e-Manual** in the popup window, and then select **Update**.



Configuring Auto Update

MENU > **Smart Hub** > **Apps Settings**



To update the e-Manual automatically, navigate to the **Smart Hub** > **Apps Settings** menu, and then set the **Auto Update** option to **On**. The e-manual is updated automatically when an update becomes available.

Using Web Browser

Web Browser is an Internet browsing app. Using Web Browser, you can surf the Internet on the TV in the same manner as you would using a PC - even while watching a TV program using PIP.

-  Use a keyboard and mouse for a more convenient web browsing experience.
-  The browsing page may differ from that on a PC.

Browsing Methods

Web Browser provides two browsing methods:  **Pointer Browsing** and  **Link Browsing**. **Pointer Browsing** enables you to move the pointer for selection while **Link Browsing** allows using the direction arrows to move the focus.

The default browsing method of Web Browser is **Pointer Browsing**. To enable **Link Browsing**, select the  icon.

Scrolling on the Web Browser



<Scrolling up or down>

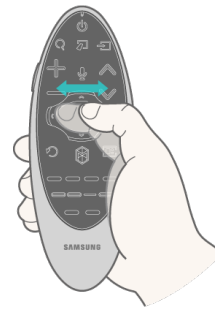















<Scrolling left or right>

Drag up / down or left / right on the touch pad in the web browser to scroll the browser screen.

Command and Status Bar at a Glance

Open the Web Browser to display the command and status bar at the top of the screen. The following items are available:

-  **Back**
Move to the previous page.
-  **Forward**
Move to the next page.
-  **Bookmarks & History**
Move to the **Bookmarks & History** screen. On this screen, add the current page to Bookmarks, or move, edit, or delete a bookmarked page. Easily access visited pages by navigating the History screen.

-  **Home Page**
Move to the main screen.
- **Address Bar**
Check the address of the current page, or enter a web page address to move to the page.
-  **Refresh** /  **Stop**
Reload the current page or stop reloading the current page.
-  **Add to Bookmarks**
Add the current page to Bookmarks.
- **Search**
Make a keyword search using the user-specified search engine.
 To change the search engine, select the  icon and then select a search engine in the Search Engine Settings.
-  100% **Zoom**
Zoom in or out of the current web page.
-  **PIP**
Use Web Browser while watching a TV program on the same screen.
-  **Link Browsing** /  **Pointer Browsing**
Select one from two browsing methods supported by Web Browser.
-  **Setting**
Configure the Web Browser settings. For more information, refer to "Browsing Preferences".
-  **Close**
Exit Web Browser.
- **New Tab**
Open a new tab.

Browsing Preferences

Select the  item on the screen. Configure the browsing settings to your needs or convenience.

 Some items may not be available depending on the web page. Unavailable items are grayed out.

- **Approved Sites**

To prevent children from accessing inappropriate web pages, limit access to pre-registered web pages.

 You will be asked to enter a password when selecting **Approved Sites**. Enter the password. The default password is 0000.

Approved Sites feature: Enable/disable the **Approved Sites feature**.

Reset password for Approved Sites: Change the password.

Add current site: Add the current web page to Approved Sites.

Manage Approved Sites: Enter the address of the web page that you want to add to Approved Sites, or select one from the list and delete it.

 Enabling the **Approved Sites feature** with no web page listed will restrict access to any web page.

- **Private Browsing On / Private Browsing Off**

Enable/disable the **Private Browsing** feature. Enabling **Private Browsing** will not save the browsing history.

 When enabling **Private Browsing**, the  icon appears at the start of the address bar.

- **PIP Settings**

Configure the PIP settings.

 This is available only if watching TV in PIP mode.

Position: Select the position of the sub picture.

- **Set Search Engine**

Set the default search engine from the list.

- **Web Browser Settings**

Configure the Web Browser Settings, such as browsing behaviors or security.

Set as Homepage: Select a web page and set it as the homepage.

Pop-up Block: Block or unblock pop-up windows.

Page Block: Block or unblock pages such as commercial pages. Manage a list of pages to block by entering the address of a web page.

General: Delete browsing history or Internet usage information, or reset Web Browser. Use Privacy Browsing to restrict access by malicious codes or phishing sites.

Encoding: Set the encoding to Auto, or select an encoding method from the list.





Pointer: Adjust the pointer speed in Pointer Browsing mode, or change the link access method.

Browser Information: Check the current version of Web Browser.

- **Help**

This will familiarize yourself with the basics of Web Browser.

Relocating an App on the Apps Screen.

1. On the **SAMSUNG APPS** screen, select to the app you want to move.
2. Press and hold the touch pad. On a standard remote, press and hold the  button. A pop-up menu appears.
3. On the pop-up menu, select **Move**.
 -  You may be asked to change the view to Custom.
4. Highlight an app you want to move. Move the app to a desired location use the arrows buttons.
5. When the app is in it's new location, press the touch pad or press the  button.
 -  You cannot move Recommended Apps.

Deleting an App from the TV

-  If an app is deleted, the data related to the app is also deleted.

Deleting an App

1. On the **SAMSUNG APPS** screen, move to the app you want to remove.
2. Press and hold the touch pad. On a standard remote, press and hold the  button. A pop-up menu appears.
3. On the pop-up menu, select **Delete**. A removal confirmation window appears.
4. Select **Yes**. The selected app is deleted.

Removing Multiple Apps

1. On the **SAMSUNG APPS** screen, move to an app you want to remove.
2. Press and hold the touch pad. On a standard remote, press and hold the  button. A pop-up menu appears.
3. On the pop-up menu, select **Multi Delete**. A check box appears on the app icons.
4. Select all the apps you want to delete. A check mark appears on each app you select. When done, select **Delete** at the bottom of the page. A removal confirmation window appears.
5. Select **Yes**. The selected apps are deleted.

Rating/Reviewing an App

On the detailed app information screen, you can rate an app or send a review to the app developer.

 To rate or review an app, you must log into your Samsung account. You can only rate or review with a TV purchasing apps and games.

Updating Apps

1. On the **SAMSUNG APPS** screen, select an app.
2. Press and hold the touch pad. On a standard remote, press and hold the  button. A pop-up menu appears.
3. On the pop-up menu, select **Update Apps**. A pop-up window listing all the apps with available updates.
4. Select the apps you want to update, and then select **Update**. All the selected apps are updated to the latest version.

 You can choose all the apps listed in the Update window at once by selecting **Select All**.

Setting Auto App Update

To update apps automatically, navigate to **Smart Hub > Apps Settings** and set **Auto Update** to **On**. The apps will then be updated automatically when an update becomes available.

Using Other App Features and Functions

[MENU](#) > [Smart Hub](#) > [Apps Settings](#) [Try Now](#)

You can configure additional app features and functions.

Enabling Automatic Tickers

Configure selected tickers to display automatically when the TV is turned on. A ticker is a service that displays stock values, news, weather updates, etc. on the screen in real-time. Enabling the Ticker service brings you up-to-the-minute information while you watch TV.

 To use this feature, make sure that an app supporting the [Auto Ticker](#) function is installed on the TV.

1. Navigate to [Smart Hub](#) > [Apps Settings](#) and select [Auto Ticker](#). The apps supporting Ticker Autorun installed on the TV will appear.
2. Select apps from the list that you want to run automatically when the TV is turned on.

Setting Push Notification

The Push notification function lets publishers of some apps installed on the TV send alarm messages containing news about their apps, modification information, etc. The messages are displayed on your screen as you watch TV.

1. Navigate to [Smart Hub](#) > [Apps Settings](#) > [Push Notification Settings](#), and then set [Push Notification](#) to [On](#).
2. On the [Push Notification](#) screen, select the apps you want push notifications for.

 The [Push Notification](#) app lists only the apps that support [Push Notification Settings](#).

Using Channel Bound Apps.

A Channel-Bound App is an app that is linked to a particular channel. These apps provide services for or information about programs on the linked channel while you are watching the programs.

Navigate to [Smart Hub](#) > [Apps Settings](#) and set [Channel-Bound Apps](#) to [On](#).

 You can use this feature only when an app supporting [Channel-Bound Apps](#) is installed on the TV.

Using the On TV Panel

This function is only available in the U.S.A. and Canada.

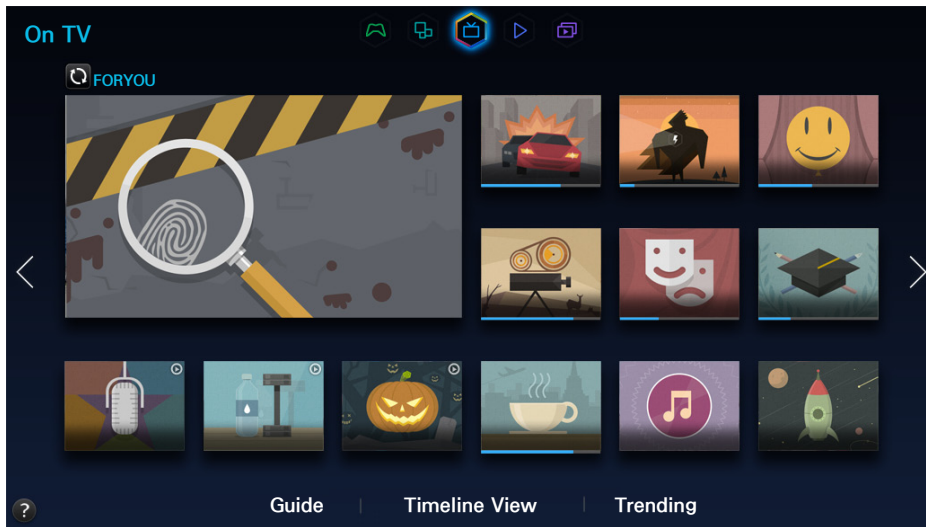

 Usability depends on your specific model and local region.

On TV displays your current program live in a small window, a list of recommended programs currently on other channels, and a list of recommended programs that will air later. You can use these lists to change the channel and watch another program. You can also use these lists to view more information about recommended programs running later, including how much time is left until they air. In addition, you can set up a Schedule Viewing of a program that hasn't aired.

To view a program recommended by **On TV**, select the image. The TV changes the channel and displays the program you selected.

 Availability of recommended content depends on the specific model and area.

 You must connect the TV to the Internet to use **On TV**.

 The channels or programs recommended by **On TV** may differ from the actual channels or programs depending on the broadcast information provider.

You can use the following features by selecting the buttons at the bottom of the screen.

- **Viewing the Program Schedule of Digital Channels**

Select **Guide** at the bottom of the screen to view the program schedule of each digital channel. You can check the program schedule and even set up a Schedule Viewing. For more information about **Guide**, refer to the "Using the Guide" section.

 The Guide provides information only about digital channels. Analog channels are not supported.

- **Program Recommendations by Time**

Select **Timeline View** at the bottom of the screen to view program recommendations for different times of the day.

- **Popular Videos**

Select **Trending** at the bottom of the screen to see what is the most trendy or popular content on Twitter.

Using Supported Features via the Pop-Up Menu

Move the focus to a desired program, and then press and hold the touch pad or press and hold the  button. The following options are available:

 Available options may differ depending on the selected program.

- **Viewing Detailed Information**

Lets you view detailed information about the program you selected.

- **Reserving**

Lets you set up a Scheduled Viewing for the program you selected.

Viewing Detailed Program Information

1. Move the focus to a desired program, and then press and hold the touch pad or press and hold the  button. A context-sensitive menu appears.
2. On the context-sensitive menu, select **View details**. Detailed information about the selected program screen appears.

Select a program from the list to see more information about the program and to access the following options:

- **Moving to a Channel**

Jumps to the selected program's channel.

- **Reserving**

Lets you set up a **Schedule** or **Schedule Recording** for the program.

 Recording is not supported in the U.S.A and Canada.

- **Viewing Related Content**

View a list of content related to the program. If you select an item from the list, the detailed information screen of the selected item appears.

- **Rate**

Lets you rate the program.

- **Sharing**

You can share information about the selected program via an SNS.

Configuring On TV Settings

[MENU](#) > [Smart Hub](#) > [On TV Settings](#) > [Set Up Service Provider](#)

Lets you select the source of your TV programs and the source of the program information that appears on the On TV screen (the signal source, cable company provider, etc.). Follow the Instructions that appear on your TV screen when you start this function. Set Up Service Provider is only available if you have not set up Smart Hub.

Receiving Recommended Content Notification

[MENU](#) > [Smart Hub](#) > [On TV Settings](#) > [Automatic Notifications](#)

You can configure the TV to display a notification when a frequently watched program is broadcast. Navigate to [Smart Hub](#) > [On TV Settings](#) and set [Automatic Notifications](#) to [On](#).

Changing Recommendation Type

[MENU](#) > [Smart Hub](#) > [On TV Settings](#) > [Recommendation Type](#)

Lets you choose the kind of program notifications you will see. Select [Preference](#) to see notifications for shows you watch often or [Popularity](#) to see notifications for popular shows. You must enable Automatic Notifications for this function to work. See Automatic Notifications above.

Navigate to [Smart Hub](#) > [On TV Settings](#), select [Recommendation Type](#) and set it to a desired type.

Removing Adult Content from the Recommended List

[MENU](#) > [Smart Hub](#) > [On TV Settings](#) > [Block Adult Content](#)

Enabling Block Adult Content prevents the On TV screen from listing TV programs with adult content. Navigate to [Smart Hub](#) > [On TV Settings](#) and set [Block Adult Content](#) to [On](#).

Using the MOVIES & TV SHOWS Panel

This function is only available in the U.S.A. and Canada.

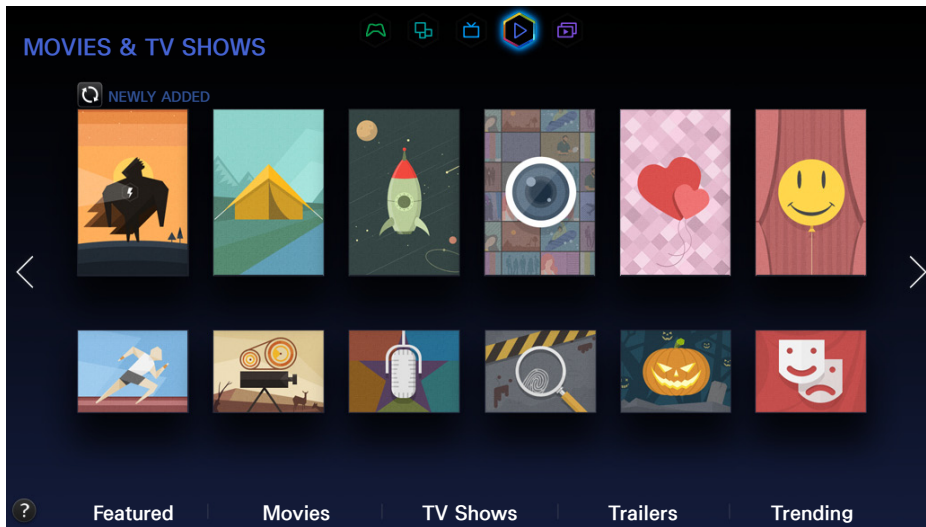

 Usability depends on your specific model and local region.

The **MOVIES & TV SHOWS** screen lets you buy or rent movies and TV shows online and stream them to your TV using apps you downloaded via Smart Hub. This is called Video on Demand or VOD. To make browsing for VOD content easier, the **MOVIES & TV SHOWS** screen displays recommended movies and TV shows and displays multiple VOD content sources so you can browse and watch all you want in one place.

 All the **MOVIES & TV SHOWS** options may not be available depending on the content you are trying to access or your region.

 The TV must be connected to the Internet for you to use **MOVIES & TV SHOWS**.

 Select  on the screen to change the recommended content list.

The following options are available at the bottom of the **MOVIES & TV SHOWS** screen:

- **Featured**

View movies or TV programs grouped according to various themes such as movies of an actor/actress who went to Hollywood, acted in a TV series, and so on.

- **Movies**

View movies by release date, popularity, or genre.

- **TV Shows**

Search TV shows by air date, popularity, or genre.

- **Trailers**

View movie trailers for upcoming movies.

- **Trending**

View movies and TV programs that are the most trendy or popular on Twitter.

 To sort the content items in each menu, select the  button and then choose a sorting criteria.

 Depending on the selected menu, the  button may not appear.

Using Supported Features via the Pop-Up Menu

On the **MOVIES & TV SHOWS** screen, select a movie or TV program, and then press and hold the touch pad. On a standard remote, press and hold the  button. A list with the following options appears:





 Available options may differ depending on the selected content.

- **Play Content Now**

The pop-up window displays the names of one or more content providers. Select a content provider to play your selected movie or TV program now.

 If the app for the content provider you selected is not installed on your TV, a pop-up window appears. In the pop-up window, select to display the app's information page or to install the app immediately. Note that you can also install the app from the app's information page.

Watching a Movie/TV Program

-  If you are using **MOVIES & TV SHOWS** for the first time, or you have not logged into your Samsung account, the **MOVIES & TV SHOWS** screen displays only new and popular movies and TV shows. To view a custom recommended list, you must have used **MOVIES & TV SHOWS** for a period of time and you must first log into your Samsung account.
-  In addition, if you have been using **MOVIES & TV SHOWS** for a period of time, you can also view your frequently played content list.
- 1. On **MOVIES & TV SHOWS** screen, select a movie or TV program you want to watch. Detailed information about your selection appears on the screen.
- 2. On the detailed information screen, select a provider app icon to play the content. The selected app is launched, and you can view detailed information about the content in the app.
 -  If the app for the content provider you selected is not installed on your TV, a pop-up window appears. In the pop-up window, select to display the app's information page or to install the app immediately. Note that you can also install the app from the app's information page.
- 3. You can play the content by selecting **Play** or **Start** in the detailed information screen.
 -  If the selected content is free, you can instantly watch the content. If the content is for-pay content, you must first purchase the content in the app (In-App Purchase).
 -  The purchasing procedures in each app may differ depending on the app. You may need to log into the service or site that provides the app, or enter payment information.

Preventing Children from Watching Adult Content

MENU > **Smart Hub** > **VOD Rating Lock**



You can lock content rated as adult so that children cannot access it.

Navigate to **Smart Hub** and set **VOD Rating Lock** to **On**.





-  To turn the **VOD Rating Lock** on or off, the security password is required.

Rating and Sharing a Purchased Content

Rating Content

1. Select content on the **MOVIES & TV SHOWS** screen. Detailed information about your selection appears on the screen.
2. Select the  button on the detailed information screen. A pop-up window appears.
3. In the pop-up window, you can set the star score by using the  and  buttons.

Writing a Content Review on an SNS (Social Networking Site)

1. Select content on the **MOVIES & TV SHOWS** screen. Detailed information about your selection appears on the screen.
2. Select either the  or  button in the detailed information screen. The login page of the selected SNS appears.
 -  If you have linked your Samsung account to your SNS account, you are automatically logged into the SNS when you log into your Samsung account. For information about linking your Samsung account to an SNS account, refer to the "Linking Your Samsung Account to External Service Accounts" section.
3. On the SNS login screen, enter your SNS ID and password to log into the SNS.
 -  If you have linked your Samsung account to the SNS account, you can skip this step.
4. In the pop-up window, type the article you want to post to the SNS, and then select **Post**. The article is posted to the SNS.

Using the Multimedia Panel (Playing Photos, Videos, and Music)

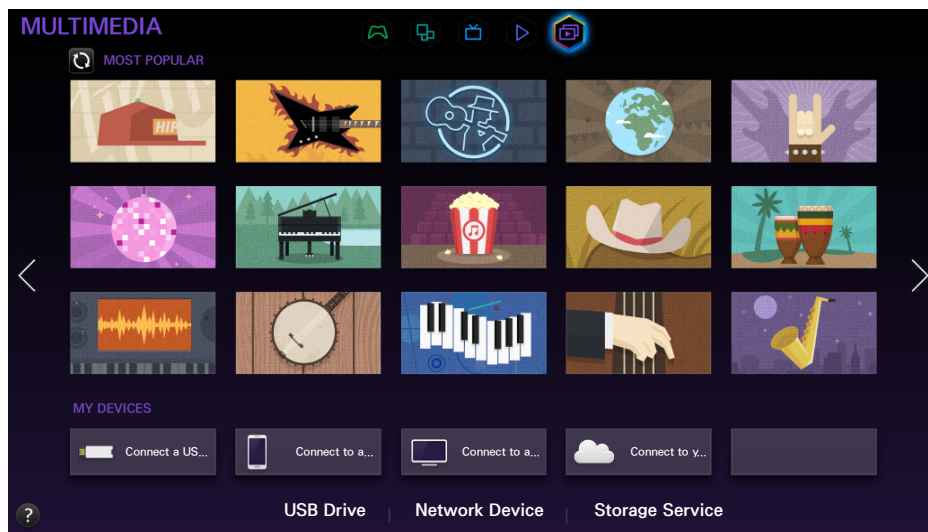





 Usability depends on your specific model and local region.

The Multimedia Panel lets you play media content saved on USB devices, smartphones, cameras, computers, or in a Storage Service site on the TV.

 You cannot play media content if the content or the storage device is not supported by the TV. For more information, refer to "Read Before Playing Photo, Video, or Music Files".

 Backup important files before connecting a USB device. Samsung is not responsible for damaged or lost files.



Playing Media Content Saved on a USB Device

1. Select **USB Drive** on the **MULTIMEDIA** panel. The USB devices connected to the TV are listed.
2. Select the device you want to connect to. The folders and files in the selected USB are listed.
3. Select the media content you want to play from the list. The media content plays.
 -  Alternatively, navigate to the media content you want to play, and then press the ► button to play the content.
4. To exit, press the ■ button or **RETURN** button.
 -  If you connect a USB device to the TV while watching the TV, the New Device Connected pop-up appears. Select All, Music, Videos, or Photos, and then press the touch pad. On a standard remote, press the  button. The folders and files on the USB device are listed.
 -  Alternatively, if you select a USB device on the **Source** screen, a pop-up window appears on the screen displaying the folders and files of the USB device.

Safely Removing a USB Device

1. Press the **SOURCE** button. The Source screen appears.
2. Navigate to the USB device you want to remove. Press and hold the touch pad on the Samsung Smart Control or the  button on a standard remote. An options list window appears.
3. Select **Remove USB** in the list.

Playing Multimedia Content Saved on a Computer/Mobile Device

-  To view a guide about Computer connections, select **Connect to a PC** on the **MULTIMEDIA** panel.
-  To view a guide about Smartphone or tablet connections, select **Connect to a Phone** on the **MULTIMEDIA** panel.

Allowing Connections with a Computer/Mobile Device

To play multimedia content located on a computer or mobile device on the TV, you need to:

- First, establish the connection to the computer or device.
- Then, allow the connection with the computer/mobile device on the TV.

For information about establishing connections, see the "Connecting to a Computer" and "Connecting To a Mobile Device" sections.

To allow a connection with a computer or mobile device, follow these steps:

1. Select **Network Device** on the **MULTIMEDIA** panel. The devices connected to the TV are listed.
2. Select **Options**, and then **Multimedia device settings**. The devices connected to the TV are listed with their settings.







 Alternatively, select **Multimedia Device Settings** from the **Network** menu to see the list of the devices connected to the TV with their settings.

3. Allow the connection with the device you want to connect to the TV. You can only play media files from devices that have been allowed to connect to the TV.





 If a computer or mobile device asks that it be allowed to connect, the connection allowance confirmation window appears on the TV so that you can easily connect it.

 You can connect to a computer or mobile device on any DLNA DMC device, such as this TV. The DLNA DMC function enables you to connect a mobile device to the TV, search for multimedia content and control play operations on the TV.





When Connected Through DLNA Using Your Home Network

-  To connect a computer through DLNA using your home network, refer to the "Connecting to a Computer" section.
 -  To connect a mobile device through DLNA using your home network, refer to the "Connecting To a Mobile Device" section.
 -  You may experience compatibility issues when attempting to play media files via a third-party DLNA server.
 -  The content shared by a computer or a mobile device may not play depending on the encoding type and file format of the content. In addition, some functions may not be available.
 -  The multimedia content may not play smoothly depending on the network status. If this occurs, transfer the content to a USB storage device, and then play content from the device.
1. Select **Network Device** on the **MULTIMEDIA** panel. The devices connected to the TV are listed.
 2. Select a device connected through DLNA using your home network, the folders and files shared by the selected device are listed.
 3. Select the media content you want to play from the list. The media content plays.
-  Alternatively, move to the media content you want to play, and then press the ► button to play the content.

When Connected Through Samsung Link



-  To connect a computer through Samsung Link, refer to the "Connecting to a Computer" section.
 -  To connect a mobile device through Samsung Link, refer to the "Connecting To a Mobile Device" section.
 -  The content shared by a computer or a mobile device may not play depending on the encoding type and file format of the content. In addition, some functions may not be available.
 -  The multimedia content may not play smoothly depending on the network status. If this occurs, transfer the content to a USB storage device, and then play content from the device.
1. Navigate to the **Smart Hub** > **Samsung Account** menu, and then select **Log In** to sign in to your the Samsung account.
 2. Select **Storage Service** on the **MULTIMEDIA** panel. The devices connected to the TV are listed.
 3. Select a device connected through Samsung Link. The folders and files shared by the selected device are listed.
 4. Select the media content you want to play from the list. The media content plays.
-  Alternatively, move to the media content you want to play, and then press the ► button to play the content.

Connecting through Smart View 2.0

-  To connect a computer through Smart View 2.0, refer to the "Connecting to a Computer" section.
 -  To connect a mobile device through Smart View 2.0, refer to the "Connecting To a Mobile Device" section.
 -  The content shared by a computer or a mobile device may not play depending on the encoding type and file format of the content. In addition, some functions may not be available.
 -  The multimedia content may not play smoothly depending on the network status. If this occurs, transfer the content to a USB storage device, and then play content from the device.
1. Select **Network Device** on the **MULTIMEDIA** panel. The devices connected to the TV are listed.
 2. Select a device connected through Smart View 2.0. The folders and files shared by the selected device are listed.
 3. Select the media content you want to play from the list. The media content plays.
-  Alternatively, move to the media content you want to play, and then press the ► button to play the content.

Playing Media Content Saved in a Storage Service

Storage Services such as Dropbox and SkyDrive save user content such as photos, videos, and music files on a remote server accessible through the Internet. When your TV is connected to the Internet, you can view or play the media content saved in a Storage Service on the TV.

-  To play the content in a Storage Service, you must log in to your Samsung account and link the Samsung account to the Storage Service account. For the information about linking your Samsung account to a Storage Service account, refer to the "Linking Your Samsung Account to External Service Accounts" section.
1. Navigate to the **Smart Hub** > **Samsung Account** menu, and then select **Log In** to sign in to your the Samsung account.
 2. Select **Storage Service** on the **MULTIMEDIA** panel. The devices linked with your Samsung account appear.
 3. Select a desired Storage Service. The folders and files in the selected Storage Service are listed.
 4. Select the media content you want to play from the list. The media content plays.
-  Alternatively, move to the media content you want to play, and then press the ► button to play the content.

Buttons and Functions Available While Viewing Photos

The TV displays the buttons below when you press the touch pad - or the  button on a standard remote - while viewing photos from a multimedia source. The playback buttons disappear if the **RETURN** button is pressed.

- **Pause / Play**





Start or stop the slideshow. Using slideshow, you can play all the photos in a folder one by one.

- **Previous / Next**

View the previous or the next photo.

- **Settings**

The following functions are available when you select the Settings button.

Function	Description
Slideshow Settings	Speed: Set the slideshow speed. Effects: Apply transition effects for the slide show.
Rotate	Rotate the photo.
Zoom	Zoom in by up to a factor of 4.
Picture Mode	Change the Picture Mode setting.
Background Music	Listen to background music while viewing photos.  The music file must be saved in the same device as the photo file.  When background music plays, the mini player appears on the screen. Using the mini player, you can pause the current music file or play another music file.
Sound Mode	Change the Sound Mode setting.  This option is supported only when background music is playing.
Select Speakers	Choose the speakers to play the background music through. Only available if you have a home theater or receiver connected to the TV.
Send	This function is the same as the 'Copy' function of a computer. Using this function, you can send the current photo to another storage device.  To see a list of the storage devices supported by this feature, refer to "Compatible Storage Devices for File Transfers".
Information	View detailed information about the current photo.



Buttons and Functions Available While Viewing Videos

The TV displays the buttons listed below when you press the touch pad - or the  button on a standard remote - while viewing videos from a multimedia source. The playback buttons disappear if the **RETURN** button is pressed.

- **Pause / Play**

Pause or play the video.



When the video is paused, you can use the following functions. The TV does not play audio when the video is paused or when you are using the Step or Slow Motion functions described below.

- **Step:** Whenever you press the  button, it scans the paused video one frame at a time.
- **Slow Motion:** Select the  button to play the video in slow playback speed (1/8, 1/4, 1/2).

- **Rewind / Fast Forward**

Rewind or fast forward the video.

- **Previous / Next**

Select the  button twice to play the previous video. Selecting  once starts the current video from the beginning.

To play the next video, select the  button.

- **Settings**

The following functions are available when you select the Settings button.

Function	Description
Select Scene	<p>Thumbnails: Select a scene and play the video from the scene.  Thumbnails is not available if 1) the thumbnail of the video is not extracted yet, 2) the video contains audio only or 3) the video play time is shorter than 60 seconds.</p> <p>Chapter Titles: Select and play another video in the same folder.</p> <p>Time Bar: You can use the < and > buttons to scan through the file in 10-second intervals or enter a specific time value to jump to that point in the video.</p>
Subtitle	<p>Control the subtitles of the video.</p> <p>Language: Turn the subtitles on or off.</p> <p>Sync: When the video and the subtitles are not synchronized, you can adjust the synchronization.</p> <p>Reset Sync: Reset the subtitle synchronization adjustment to 0.</p> <p>Size: Choose the font size for the subtitles.</p> <p>Encoding: If the subtitles are not working, you can change the encoding language.</p>
Repeat	Set the repeat mode. Repeat One repeats the current video only. Repeat All repeats all videos contained in the folder.
Rotate	Rotate the video.
Picture Size	Change the picture size. The supported video sizes are determined by the video content.
Picture Mode	Change the Picture Mode setting.
Sound Mode	Change the Sound Mode setting.
Select Speakers	Choose the speakers to play the audio through. Only available if you have a home theater or receiver connected to the TV.
Audio Language	Choose a desired audio language. This option works only when the video supports multi-track sound.
Information	View detailed information about the video.

Buttons and Functions Available While Playing Music

The TV displays the buttons listed below when you press the touch pad - or the  button on a standard remote - while playing music files from a multimedia source. The playback buttons disappear if the **RETURN** button is pressed.

- **Pause / Play**

Pause or resume the music.

- **Rewind / Fast Forward**

Rewind or fast forward the music file. Repeatedly select the button to make the rewind/fast forward speed up to 3 times faster. To restore normal playback speed, select **▶**.

- **Previous / Next**

Select the **⏮** button twice to play the previous music file. Selecting **⏮** once starts the current music file from the beginning.

To play the next music file, select the **⏭** button.

- **Repeat**

Set the repeat mode. **Repeat One** repeats the current music file only. **Repeat All** repeats all music files contained in the folder.

- **Shuffle**

Play the music files in random order.

- **Select Speakers**

Choose the speakers to play the audio through. Only available if you have a home theater or receiver connected to the TV.

- **Sound Mode**

Change the Sound Mode setting.

Functions on the Media Content List Screen

On the media content list screen of a storage device, the following functions are provided.

- **Filter**

Filters the media content so only one type of content - photo, video, or music - is displayed.

- **Sort By**

Sorts the content list. The sort criteria change depending on the type of content you have selected.









 This function is not available when **Filter** is set to **All**.

- **Options**

Displays viewing and playing options. The options displayed vary, depending on the type of content you have selected. Not all options listed below are displayed at the same time.

 This function is not available when **Filter** is set to **All**.

The following options are available when you select the Options button.

Function	Description
Slide Show	Start the slide show.  Available for photos only. If Sort By is set to Folder , this function is not available.
Play Selected	Play only content you want from the media content list.
Send	This function is the same as the 'Copy' function of a computer. Using this function, you can send media content to another storage device.  To see a list of the storage devices supported by this feature, refer to "Compatible Storage Devices for File Transfers".
Encoding	If the media content's title will not display properly, you can change the encoding language.  Available for music files only.
Rename Playlist	You can change the name of the playlist you created.  Available for music only.
Delete Playlist	Delete a playlist that you created.  Available for music only.
Add to Playlist	Add a file to a playlist that you created or create a new playlist.  Available for music files only.
Index	For quick access to a content item in a large list, use the Index function. Select a format and then a character. The TV jumps to the section of the list that begins with the character you selected.  This is not available when Sort By is set to Folder .  You can set the Index to sort and search by date, number, or English alphabet, in descending or ascending order.

Using the NewsON Panel

This function is not available in the U.S.A. and Canada.

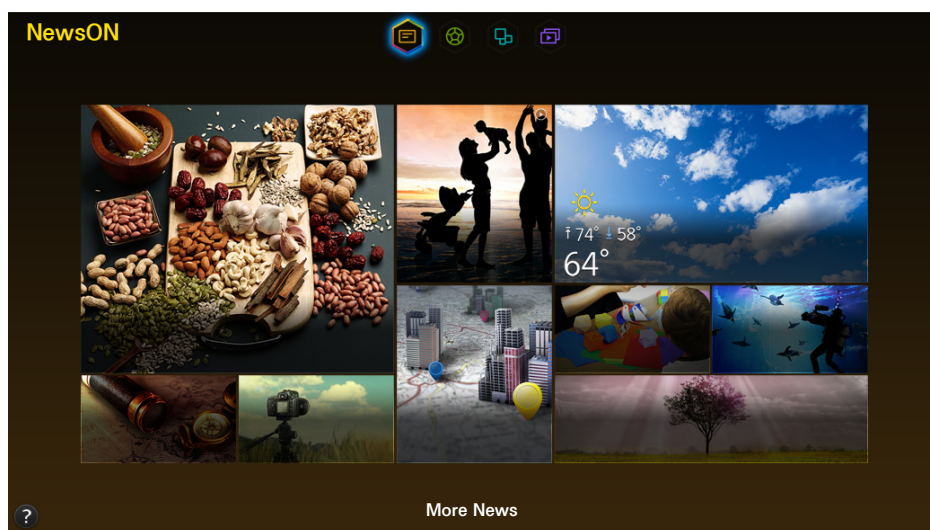

 Usability depends on your specific model and local region.

NewsON provides real-world news and weather information all in one place - no need for a newspaper, smartphone, or computer.

You can find daily information on a wide variety of topics in a smart and convenient way, updated in real time. **NewsON** brings you the latest headlines, top stories, popular issues, and weather forecasts.

News

News articles are updated in real time. Simply select an article on the screen. The selected article will be displayed on the screen in detail.

For longer articles, press the ▲ or ▼ button on the remote control to scroll the screen.

To move to a different article, press the ◀ or ▶ button on the remote control.

Weather

Weather information is provided for major cities of your country. Select a weather-related item on the screen. The selected item will be displayed in detail.

Using the SOCCER Panel

This function is not available in the U.S.A. and Canada.

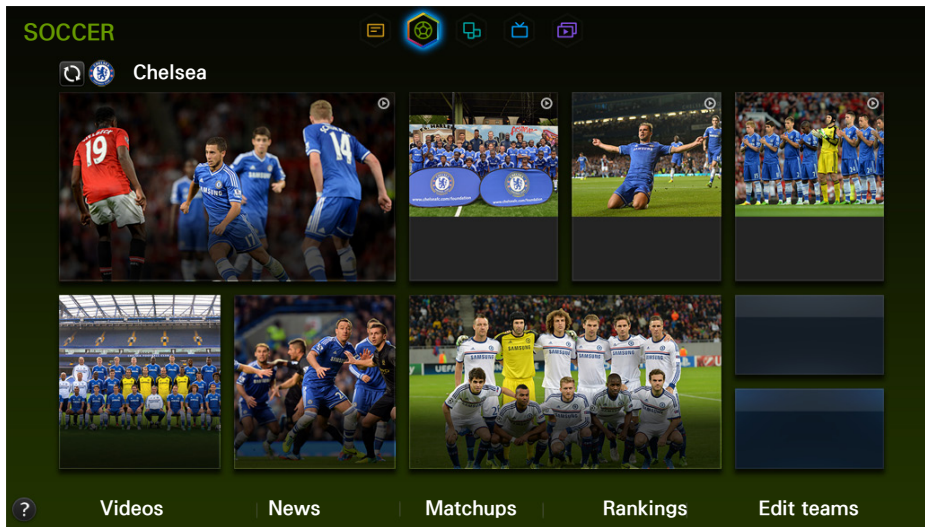

 The screen shown may vary depending on the model.

The **SOCCER** panel offers a variety of information about world soccer matches, featuring videos, news, matchups, and ratings. Adding a favorite team to the Favorite list allows easy access to information about team.

 Before you use the **SOCCER** panel, check if the TV is connected to the Internet. An Internet connection is required to access the **SOCCER** panel.

 To view the Quick Guide, select the  button.

Move to the navigation bar at the bottom of the screen to access the following options:

- **Game highlights**

Select **Videos** to view game highlights of your favorite soccer team.

- **Hot news**

Select **News** to check the latest news from various information sources around the world.

- **Matchup schedules**

Select **Matchups** to check the matchup schedule and game records of your favorite team. Also, if the game is in progress or has ended, you can check detailed information about the game.

- **Team and player rankings**

Select **Rankings** to view team standings or a player's stats (goals, assists).

- **Setting your favorite team**

Select **Edit teams**, and add a team you support to the favorite list.



Setting Your Favorite Team

Once you set a favorite team, the **SOCCKER** panel will be rearranged to offer information on your favorite team.

 If you have never set a favorite team, select **Set your favorite team!!** and simply add a team to the list.

 You can add up to 6 teams to the list.

1. Select **Edit teams** on the **SOCCKER** panel.
2. Select **+**.
3. Select a league to which the selected team belongs.
4. Select the team.



 If you have added multiple teams to the list, select the  button on the **SOCCKER** panel to move to the next team section.

Modifying the Favorite Team List

1. Select **Edit teams** on the **SOCCKER** panel.
2. Select a favorite team to change.
3. Select the league to which the favorite team belongs.
4. Select the team. The team you selected replaces the current team.

Deleting favorite teams

1. Select **Edit teams** on the **SOCCKER** panel.
2. Select **Options** > **Delete**.
3. Select all of the teams you want to remove.
4. Select **Delete** to remove all the selected teams from the list.

 On the **Edit teams** screen, you can also delete teams. Select the team you want to delete, and then press and hold the  button or the touch pad.

Controlling the TV with Your Voice (Voice Control)

[MENU](#) > [System](#) > [Voice Control](#) [Try Now](#)

You can access and select certain menu options and functions using voice commands. For more effective voice recognition, speak slowly and clearly in the language specified in the [System](#) > [Voice Control](#) > [Language](#) option.

- **Interactive and Imperative Voice Control**

Voice Control has two modes: Interactive voice control and Imperative voice control. Interactive voice control lets you give "conversational" instructions to the TV. Imperative voice control requires you to use pre-defined commands. To use Interactive voice control, you must set up Smart Hub, set the clock, and agree to the user's agreement on the use of terms. If you try to use Interactive voice control without completing all of these requirements, the TV displays a notification pop-up. If the pop-up appears, follow the on-screen instructions and complete the necessary settings. Imperative voice control is available regardless of the Interactive voice control settings.

 Please read through the instructions before using Voice Control. For more information, refer to "Read Before Using Voice, Motion, or Face Recognition".

 If you use the [Voice Control](#) function interactively at least once, the TV will change the on-screen menu name from [Voice Control](#) to [Voice Interaction](#).

Using Imperative Voice Control

1. Press the **VOICE** button on the Samsung Smart Control. When the microphone icon appears on the screen, you can use the [Voice Control](#) function.
2. Say a command. You can use Voice Control to operate the TV when you are watching a TV program or other videos.

 Say the command 4 to 6 inches from the microphone on the Samsung Smart Control. Voice commands may not be recognized properly if you speak too softly or loudly. The optimal volume for voice commands is between 75 dB and 80dB.

Using the Voice Recognition Tutorial [Try Now](#)

[MENU](#) > [Support](#) > [Voice Recognition Tutorial](#)

The tutorial lets you familiarize yourself with the basics of using Voice Control. Run [Voice Recognition Tutorial](#) from the [Support](#) menu, or run Voice Control and say "Quick Guide".

Learning Voice Control Basics

- **Moving the focus**

Say "**Focus Left**", "**Focus Right**", "**Focus Up**", or "**Focus Down**" to move the focus. These commands can only be used in situations when the focus can be moved.

- **Selecting an item**

Say "**Select**" to confirm the selection.

- **View available Voice Commands:**

Say "**View commands**". A list of basic voice commands available in context is shown.

- **View all Voice Commands:**

Say "**Help**" to display a complete list of voice commands by category. Say the name of a category.

- **Deactivating Voice Control**

Say "**Close Voice Recognition**", or press the **VOICE** button. This terminates Voice Control.

 The TV recognizes predefined voice commands only. These voice commands may differ from the manual depending on the version of the TV.

Changing the Voice Control Language [Try Now](#)

MENU > **System** > **Voice Control** > **Language**

Navigate to **System** > **Voice Control** > **Language**, and then select a preferred language from the list. Now you can use Voice Control in the specified language.

 Interactive Voice Control is not available in some languages. If the language you wanted initially is not available, choose a different language.

Using Interactive Voice Control

Interactive Voice Control allows you to set up a Schedule Viewing, access VODs (Videos on Demand), search for and launch applications, and execute various other functions using specified voice commands without having to remember specific commands or keywords. Saying "Schedule Viewing *(Title)", for example, instructs the TV to schedule a program for later viewing.

 If you use the Interactive **Voice Control** function at least once, the TV will change the on-screen menu name from **Voice Control** to **Voice Interaction**.

Activate Voice Interaction and say a command. See the examples below:

- **When you don't know which channel a specific program is on:**

"Run *(Title)" / "Play *(Title)" / "Watch *(Title)"

- **When you want to find a specific program or content item**

"*(Title)" / "Find *(title)"

- **When you want to watch a program featuring a specific actor:**

"*(cast member)" / "Anything with *(cast member)"

- **When you want to reserve and record a program or cancel a scheduled program.**

"Schedule Viewing *(Title)" / "Schedule Recording *(Title)" / "Record *(Title)" / "Cancel scheduled item" / "Remind me to watch OOO(Title)."

 Recording is not supported in the U.S.A and Canada.

- **When you want to know specific information:**

"Recommend something to me." / "Are there any popular drama (genre) out?" / "Show me all sitcoms (genre) playing on tomorrow (date)." / "Show me something good."

- **When you want program recommendations:**

"Do you have any recommendations?" / "Anything interesting on tonight?" / "Show me Comedies (genre) on now."

- **When you want to watch a program of a specific genre:**

"action movie (genre)" / "Find actions (genre)." / "Search for Comedies (genre)."

- **When you want to operate the TV:**
"***(channel name)" / "Channel *(Number)" / "Volume *(level)"
- **When you want to install or remove an app:**
"Show the Information about *(Title)" / "Install *(app name)" / "Delete *(app name)"
- **When you play an app for the camera, such as skype, or for fitness:**
"Camera" / "Fitness" / "Skype"
- **When you want to play for game:**
"Play *(Game title)"
- **When you log in or out on Samsung Account:**
"Sign In *(User name)" / "Sign Out *(User name)"

Enabling/Disabling TV Voice

This function is only available in the U.S.A. and Canada.

Enable/disable the TV's voice responses to your Voice Control commands. Navigate to [System](#) > [Voice Control](#) menu, and then select [TV Voice](#).

Selecting a Gender for the TV Voice

This function is only available in the U.S.A. and Canada.

Navigate to [System](#) > [Voice Control](#) > [Voice Gender](#), and select a gender for the TV voice.

Controlling the TV using Motions (Motion Control)

[MENU](#) > [System](#) > [Motion Control](#) [Try Now](#)

Motion Control lets you change channels, adjust the volume, and control the pointer while searching the web using Smart Hub.

To use the Motion Control feature, you must install a separately-sold camera on the TV.

⚠ When connecting the TV camera to 2014 Samsung TV models, make sure to connect it to the specified USB port of the TV. Other USB ports do not support the TV camera or Motion Control.

 Please note that not all apps support Motion Control.

 Please read through the instructions before using [Motion Control](#). For more information, refer to "Read Before Using Voice, Motion, or Face Recognition".

Testing Ambient Illumination Using the TV Camera

[MENU](#) > [System](#) > [Motion Control](#) > [Motion Control Environment Test](#) [Try Now](#)

Run this test before using Motion Control to ensure proper functionality.

1. Stand 5 to 11.5 feet (1.5 to 3.5m) from the TV screen. Initiate the [Motion Control Environment Test](#), and then select [Start](#). If the TV screen is reflecting light or there are objects moving in the background, the TV may not recognize the motion of your hand.
2. Face the TV camera, and follow the onscreen instructions. Raise your hand from a comfortable position with the index finger fully extended upwards, and then move your hand left or right slowly. A pointer appears on the screen when the TV recognizes the action. If recognition fails, change the hand position and try again.

Checking Ambient Noise and Illumination (Motion Control Environment Check)



[MENU](#) > [Support](#) > [Self Diagnosis](#) > [Motion Control Environment Check](#) [Try Now](#)

Navigate to the [Support](#) > [Self Diagnosis](#) menu, and then select [Motion Control Environment Check](#). This function measures the ambient noise and illumination levels around the camera and microphone of the TV to ensure they are suitable for voice and motion control use.

Activating Motion Control

[MENU](#) > [System](#) > [Motion Control](#) > [Motion Control](#) [Try Now](#)

To enable Motion Control, face the TV camera and raise your hand from a comfortable position with your index finger fully extended upwards, and then move your hand slowly left or right. When your hand is successfully recognized by the TV camera, Motion Control is activated and a pointer appears on the screen.

-  When Motion Control is activated, a pop-up window appears and guides you through the basics of using Motion Control.
-  Moving your hand out of the range of the TV camera deactivates Motion Control. To reactivate Motion Control, simply move your hand toward the TV camera within 3 seconds.
-  Motion Control may be terminated if your index finger is not fully extended or you move it too fast.

Using the Motion Control Tutorial

[MENU](#) > [Support](#) > [Motion Control Tutorial](#) [Try Now](#)

The tutorial lets you familiarize yourself with the basics of using Motion Control. From the [Support](#) menu, run [Motion Control Tutorial](#).

-  If Motion Control is activated, a pop-up window appears and guides you through the basics of using Motion Control.

Learning Motion Control Basics

The following basic motion control commands are available:

- **Moving the pointer**



Moving your hand moves the pointer accordingly.

- **Selecting an item**

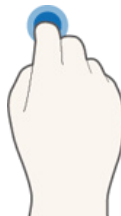

Fold down and raise your index finger to select items. This is the equivalent of clicking a mouse button. You can select a TV menu or run a function. Keeping your index finger lowered is like holding down a remote control button.

- **Returning to the previous menu**

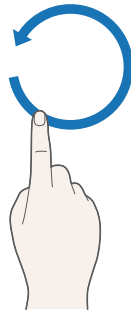

Make a circle with your hand in the counterclockwise direction to return to the previous menu.

- **Moving from one Smart Hub panel to another**

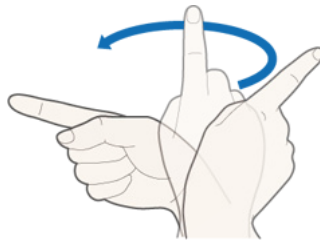

Move your hand from left to right or from right to left as you would turn a book page. You can move directly from one Smart Hub panel to another. (Example: **SAMSUNG APPS** panel → **On TV** panel)

- **Displaying the Context-sensitive Menu on Smart Hub**



Fold your index finger down for 1 second and then raise it. This displays the context-sensitive menu that is available for the selected item.

Showing and Hiding Animated Motion Guide [Try Now](#)

Navigate to **System** > **Motion Control**, and then select **Animated Motion Guide** from the menu. The TV will now display an animated guide when Motion Control is activated.

Adjusting Pointer Speed [Try Now](#)







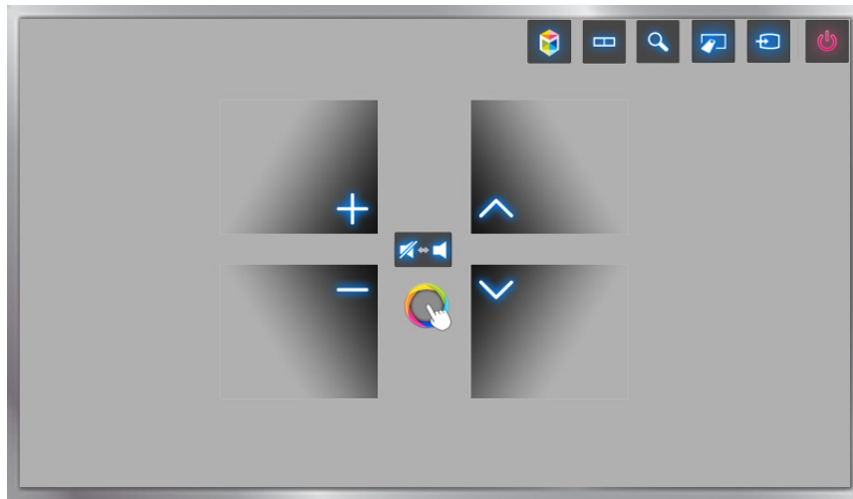

Navigate to **System** > **Motion Control** > **Pointer Speed**, and then select a pointer speed.

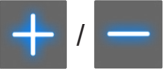
Motion Control Screen Layout

Motion Control Layout on the TV Screen

Activating Motion Control while watching the TV activates the following screen icons. These icons appear when you move the pointer to where they are positioned or when you initiate functions that need them.









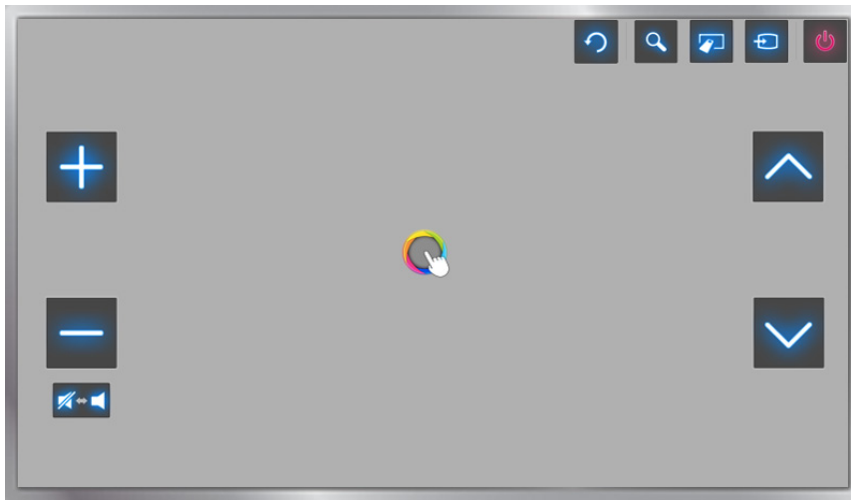

Icon	Description
	Adjusts the volume.
	Mutes or unmutes the TV.
	Changes the channel.
	Launches Smart Hub.
	You can split the TV screen and use a variety of functions simultaneously such as watching a TV program, surfing the web, and watching a video. For more information, refer to the "Using Multiple Functions on a Single Screen (Multi-Link Screen)" section.
	Press this button to search for information through the search window in various services.
	The On-Screen Remote Control appears. For more information, refer to the "Displaying and Using the On-Screen Remote" section.
	Changes the source.
	Turns the TV off.

Motion Control Layout on the Smart Hub Screen

Activating Motion Control while using Smart Hub activates the following screen icons. These icons appear when you move the pointer to where they are positioned or when you initiate functions that need them.









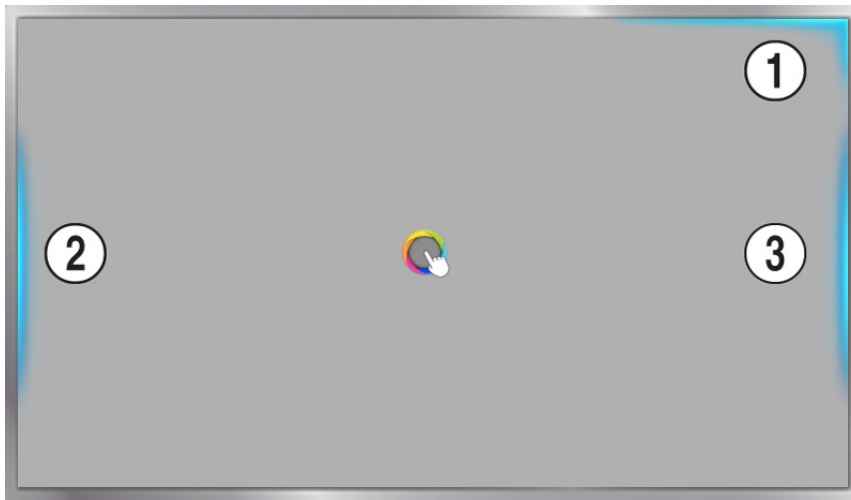



Icon	Description
	Adjusts the volume. Only available for On TV .
	Mutes or unmutes the TV. Only available for On TV .
	Changes the channel. Only available for On TV .
	Returns to the previous menu.
	Select this button to search for information through the search window in various services.
	The On-Screen Remote Control appears. For more information, refer to the "Displaying and Using the On-Screen Remote" section.
	Changes the source.
	Turns the TV off.

Displaying Hidden Icons When Using Smart Hub

When using Motion Control with Smart Hub, the icons will disappear automatically after 2 seconds of inactivity. To display the hidden icons, move the pointer to one of the three edge areas shown below (marked in blue) and then hold it there for 1 second. The icons will reappear on the screen.





Icon	Description
①	 /  /  /  / 
②	 /  / 
③	 / 

Using Face Recognition

Users can register their faces using the TV camera, and sign in to their Samsung accounts using the Face Recognition function. Only one face can be registered per account. Depending on the ambient illumination level and/or shadows over a face, the TV may have difficulty recognizing it.

To use the Face Recognition feature, you need to install a sold-separately camera on the TV. Make sure that the TV is connected to the Internet when installing the camera so that it can download the software required for Face Recognition.

 Please read through the instructions before using Face Recognition. For more information, refer to "Read Before Using Voice, Motion, or Face Recognition".

 **When connecting the TV camera to 2014 Samsung TV models, make sure to connect it to the specified USB port of the TV. Other USB ports do not support the TV camera or Face Recognition.**

Registering Your Face to Your Samsung Account

To register your face to your Samsung Account, follow the steps below. To create a Samsung Account if you do not already have one, refer to "Creating a Samsung Account".

1. Sign in to your Samsung Account ([Smart Hub](#) > [Samsung Account](#) > [Sign In](#)).
2. Navigate to [Smart Hub](#) > [Samsung Account](#) > [Edit Profile](#). The On-Screen Keyboard appears.
3. Enter your account password. When finished, select [Done](#).
4. On the Edit Profile screen, select [Register Face](#).
5. On the Face Registration screen, align your face within the red circle. When the circle turns green, the TV has recognized your face.

 Your entire face must be visible to the camera. Avoid shadows over your face. Shadows prevent the camera from recognizing your face accurately.

 Keep your expression as neutral as possible. In addition, keep your mouth closed but at the same time as neutral as possible.

 For stronger security, check the box to require a password when signing in using Face Recognition.

6. Select [Take Picture](#).
7. The TV displays your picture. Select [OK](#) to accept, [Retry](#) to take another picture, or [Cancel](#).
8. After you have selected OK, the Edit Profile screen re-appears. Select [Done](#).

 After you accept your picture, the [Sign in Method](#) changes automatically to [Face Recognition](#) on the [Edit Profile](#) screen.

 To remove your picture, select [Remove Face](#) on the [Edit Profile](#) screen.





Changing Your Login Method to Face Recognition

To change your log in method to **Face Recognition**, follow these steps:

1. Sign in to your Samsung Account (**Smart Hub** > **Samsung Account** > **Sign In**).
2. Navigate to **Smart Hub** > **Samsung Account** > **Edit Profile**. The on-screen keyboard appears. Enter your password, and then select **Done**.
3. On the Edit Profile screen, select **Sign-in Method**. In the drop down list that appears, select **Face Recognition**.
4. Select **Done**.

Signing in to a Samsung Account Using Face Recognition

To log in using **Face Recognition**, follow these steps:

1. Navigate to **Smart Hub** > **Samsung Account**, and then select **Sign In**.
2. Select your Samsung account.
3. If you have set the Samsung account sign in option to Face Recognition, the TV automatically recognizes your face. If recognition fails, try again.
 -  If you checked the Password Required box when you set up Face Recognition, you must also enter your password to log in.
 -  Your entire face must be visible to the camera. Avoid shadows over your face. Shadows prevent the camera from recognizing your face accurately.
 -  Keep your expression as neutral as possible. In addition, keep your mouth closed but at the same time as neutral as possible.
 -  Once recognition succeeds, the TV logs in to Smart Hub automatically. If the TV recognizes two or more registered faces, a list of corresponding accounts appears. Select the appropriate account. If the TV detects an unregistered face, it displays "Unregistered" on the screen.

Digital Broadcast Information at a Glance

[MENU](#) > [Broadcasting](#) > [Guide](#) [Try Now](#) [Try Now](#)

The Guide provides an overview of each digital channel's program lineup. You can check the program schedules and set up a Schedule Viewing.

Press the **GUIDE** button on the remote to launch the Guide.

 The information in the **Guide** is for digital channels only. Analog channels are not supported.



Using the Guide

To access the Guide functions, press and hold the touch pad. On a standard remote, press and hold the  button. A popup window listing the following functions appears.

Channel Filter

Channel filter lets you filter the channels in the **Guide** by the following categories: **Added Ch.**, and **Favorites 1 - Favorites 5**.

Navigating the Program Schedule

You can move the Guide by 2 hours in either direction each time you press the  or  button. You can only view programs scheduled after the current time.

Schedule Manager

This displays the schedule manager. For information about the Schedule Manager, see "Setting Up a Schedule Viewing".

Edit Favorite Channels

Edit favorites lets you designate a channel you have selected in the **Guide** as a favorite.

To use **Edit Favorite Channels**:

1. Highlight a channel you want to add to your favorites in the **Guide**.
2. Press the **TOOLS** button on the standard remote or press and hold the touch pad on the Samsung Smart Control. The Guide functions pop-up window appears.
3. Select **Edit Favorite Channels**. The Edit Favorites window appears.
4. Select the Favorites list you want to put the channel into.

Viewing Detailed Information

Recording is not supported in the U.S.A and Canada.

You can view detailed information about a selected program. The program information may differ depending on the broadcast signal and may not be available at all for certain programs.

- Select a current program on another channel, and then **View Details** to **Watch** or **Record** the program.
- Select an upcoming program, and then select **View Details** to set up a **Schedule Viewing** or **Schedule Recording**.



 For more information about watching or **Schedule Viewing** refer to "Setting Up a Schedule Viewing".

 For more information on **Schedule Recording**, refer to "Recording Programs".

Checking Current Program Info

Recording is not supported in the U.S.A and Canada.

To get information about a show, press **INFO** on the standard remote. On the Samsung Smart Control, press the **KEYPAD** button, and then select **INFO** on the On-Screen Remote.

-  To view the program info, you must first set the TV's clock. Go to **Clock** (**System** > **Time** > **Clock**).
-  The program information may vary depending on the type of incoming signal and may not be available at all for certain programs.

Select the current program in the Program Info window to instantly record the program.

Use the **<** and **>** buttons to view information about upcoming programs. Select a program to set up a **Schedule Viewing** or **Schedule Recording** for that program.

For more information on **Schedule Viewing**, refer to "Setting Up a Schedule Viewing".

For more information on **Schedule Recording**, refer to "Recording Programs".

Changing the broadcast signal

MENU > **Broadcasting** > **Antenna** **Try Now**



You can choose the appropriate DTV mode for your viewing environment. Choose **Air** or **Cable**. **Air** is suitable for homes equipped with a separate, over-the-air antenna. **Cable** is suitable for homes that have subscribed to a local cable-service or satellite-service provider.

-  Do not use this function if your TV is connected to a cable or satellite box.

Digital Channel Signal Info and Strength

MENU > **Support** > **Self Diagnosis** > **Signal Information** **Try Now**

Select **Support** > **Self Diagnosis** > **Signal Information**. This displays the digital channel's signal information and strength.



-  If your TV is attached to a separate, over-the-air antenna, you can use the signal strength information to adjust the antenna for increased signal strength and improved HD channel reception.
-  Signal information is only available for digital channels.

Recording Programs

This function is not available in the U.S.A. and Canada.



You can record current and upcoming programs using a USB device instead of a video recorder.

However, this is only available for digital channels. The  icon appears next to programs and channels for which a Schedule Recording has been set.

-  We recommend a USB hard disk drive with a minimum speed of 5,400rpm for TV recording. USB memory sticks are not supported.
-  Read all precautions before using the recording feature.

Formatting a USB Recording Device

To record programs on a USB device connected to the TV, the device must first be formatted for the TV. Use the **Format Device** option to prepare the USB device.

-  Formatting a USB device erases all data contained on the device. Back up data you want to retain before proceeding. Samsung will not be held responsible for damaged or lost files.
1. Press the  button to open the **First Screen**, and select the Panel icon. You will move to the Panel screen.
 2. Select **USB Drive** from the bottom of the **MULTIMEDIA** screen. A list of connected devices appears.
 3. Select the USB device to use. A pop-up window appears.
 4. Select **Yes**. This will bring up the **Format Device** screen and allow you to format the device for TV recordings.
 5. Once formatting is complete, the USB device is tested to see if it has been properly formatted. You will be able to start using the device after the test is completed. If the device fails the test, it means that this device cannot be used to record TV programs.

Managing USB Recording Devices

To access functions that let you manage USB recording devices, follow these steps:

1. Press the  button to open the **First Screen**, and select the Panel icon. You will move to the Panel screen.
2. Select **USB Drive** from the bottom of the **MULTIMEDIA** screen. A list of connected devices appears.
3. Select a USB recording device from the list. The list of recordings contained on the device appears.
4. Select **Options** from the top of the screen, and then **Manage Device**. The **Manage Device** screen appears.

The following options are available on the **Manage Device** screen:

- **Format Device**

Formats the USB device for TV recordings.

- **Check Device**

Check the malfunctions of USB device. If the USB have a problem, try to recover.

- **Device Performance Test**

Tests the performance of the USB device. This test tells you whether the USB device can be used for TV recordings.

- **Default Recording Device**

If there are multiple USB recording devices connected to the TV, use this option to specify the default device.

Recording Programs

You can record current and upcoming programs.

Instant Recording

Press the **●** button to begin recording the current program right away.

Using the Instant and Schedule Recording options from the Guide

Select a current program from the **Guide**, and then select **INFO** on the On-Screen Remote. You can instantly start recording the program. Alternatively, select a program that will air in the future.

Using the Instant and Schedule Recording options from Program Info

Press the **INFO** on the On-Screen Remote to display information about the current program. In the information screen, select a program that is currently airing to start recording it right away. Alternatively, press the **<**, **>** buttons and select a program that will air in the future to record it.

Using Schedule Recording to Record on a Specified Date and Time

1. Select **Broadcasting** > **Schedule Manager**.
2. Select **Schedule** from the **Schedule Manager** to bring up a pop-up menu. Select **Schedule Recording**.
3. Specify the **Antenna**, **Channel**, **Repeat**, **Start Time**, and **End Time** options for the program you want to record, and then select **OK** to finish.

Buttons and Functions Available While Recording a Program

Press the  button while recording a program. The following buttons and the recording progress bar appear on the screen.

- **Information**

Displays detailed information about the program being recorded.



The program information may differ depending on the broadcasting signal and may not be available at all for certain programs.

- **REC Time**

Lets you select the recording time.

- **Stop Recording / Go to Live TV**

Stops recording. / Shifts viewing to live TV.

- **Rewind / Fast forward**

Repeatedly select the Rewind or Fast Forward button to speed up rewind or fast forward to maximum speed in 5 steps. To restore normal playback speed, select **Play**.



You cannot use **Fast forward** while watching a program that is currently being broadcast.

- **Pause / Play**

Lets you pause or resume the video.

- **Channel List**

Displays the channel list.

- **Tools**

Launches the Tools menu. The Tools menu provides functions that you can use while watching a recorded program.

Managing the Schedule Recording List

[MENU](#) > [Broadcasting](#) > [Schedule Manager](#)

You can change the settings of scheduled recording sessions or cancel scheduled sessions altogether.

Deleting Schedule Recording Sessions

You can delete scheduled recording sessions.

1. Select [Broadcasting](#) > [Schedule Manager](#).
2. Select a session from the [Schedule Manager](#). A pop-up window appears.
3. Select [Delete](#). This cancels the selected recording session.



Editing Schedule Recording Sessions

You can change the settings of scheduled recording sessions.

1. Select [Broadcasting](#) > [Schedule Manager](#).
2. Select a session from the [Schedule Manager](#). A pop-up window appears.
3. Select [Edit](#), and then change the settings of the selected session.
4. Once finished, select [OK](#). This applies the changes you made to the selected recording session.

Viewing Recorded Programs

Recorded broadcasts can be viewed using the **USB Drive** option at the bottom of the **MULTIMEDIA** screen.

1. Press the  button to open the **First Screen**, and select the Panel icon. You will move to the Panel screen.
2. Select **USB Drive** from the bottom of the **MULTIMEDIA** screen.
3. Select a USB recording device. A list of recordings appears.
4. Select a recording file from the list or select the  button on the On-Screen Remote or press the  button on the standard remote to play the selected file.

Buttons and Features Available while playing Recordings

On a Standard remote, press the  button. On the Samsung Smart Control, press the touch pad. The following buttons appear. Pressing the **RETURN** button hides the buttons.

 Buttons that appear are different depending on the file being played.

- **Zoom**

If the video was recorded in **Soccer Mode**, you can pause the current file (recorded program), and then select and **Zoom** in on one of 9 sections of the paused picture.

 Press the **A** button for easier use.

 You can only use this function for programs recorded in **Soccer Mode**.



- **Stop**

Stop the files being played (recorded programs) and then move the stored files.

- **Pause / Play**

Pause the file (recorded program) or resume playing the file if paused.

When the video is paused, you can use the following functions. However, there is no audio while the video is paused.

- **Step:** Select the  button, to scan through a video one frame at a time.
- **Slow Motion:** Select the  button to play the video back at 1/4 the normal speed.

- **Rewind / Fast forward**

Rewind or fast forward the recorded program. Repeatedly select the Rewind or Fast Forward button to speed up rewind or fast forward to maximum speed in 5 steps. To restore normal playback speed, press the ► button.

 You cannot use **Fast forward** while watching a program that is currently being broadcast.

- **Previous / Next**

To play the previous file (recorded program), press ◀◀ twice on the standard remote or select ◀◀ on the On-Screen Remote. Pressing ◀◀ once reloads the current video from the beginning.

To play the next file (recorded program), press the ▶▶ button on the standard remote or select ▶▶ on the On-Screen Remote.

 This function is not available when the program is recorded in soccer mode.

- **Highlight Player**

You can select **Highlight Player** and view highlights of the current recording.

 You can only use this function when highlights of a program which was recorded in **Soccer Mode** have been saved.

- **Live TV**

This function lets you watch a live program in the PIP window while watching a recorded video on the main screen.

 Switching channels is not supported.

 You can only use this function for programs recorded in **Soccer Mode**.

- **Tools**

Function	Description
Search	Search Titles: Select and play a different file located in the same folder. Search Time bar: Press left/right button to scan through the file in 1-minute increments or enter a specific time value to jump to that point in the video.
Caption	Turn the subtitles On or Off .
Repeat Mode	Changes the repeat mode. Choose Repeat One to play the current file repeatedly or Repeat All to play all files in the same folder repeatedly.
Picture Size	Use to change the size of the screen. The supported picture sizes vary depending on the video.
Picture Mode	Use to change the picture mode.
Sound Mode	Use to change the sound mode.
Select Speakers	Choose the speakers to play the audio through. Only available if you have a home theater or receiver connected to the TV.
Multi-Track Sound	Use to select a different audio language. This option is only available with files that support multi-track sound.
Information	Displays detailed information about the current file.

Managing Recorded Files

Select **USB Drive** on the **MULTIMEDIA** screen to lock/unlock, rename, delete, and generally manage recorded files.

1. Press the  button to open the **First Screen**, and select the Panel icon. You will move to the Panel screen.
2. Select **USB Drive** from the **MULTIMEDIA** screen.
3. Select a USB recording device. A list of recordings appears.

Saved File List Features

- **Sorting the Saved File List**

Sorting with **Sort By**: Select **Sort By** at the top of the screen, and then select a viewing mode. The list is sorted based on the selected viewing mode.

Grouping with **Filter**: Select **Filter** at the top of the screen, and then select a filter. The list is refreshed to show only files that match the selected filter.

- **Options**

Function	Description
Play Selected	Select files from the file list to create a playlist, and then select Play . The TV plays the files you selected. If the View mode is set to Folder view , only the files contained in the same folder can be selected. To add files from other folders to the playlist, change the View mode.
Lock	Locking files prevents them from being deleted. Select the files, and then select Lock . This locks all selected files.
Unlock	Use this option to unlock any locked files. Select the files, and then select Unlock . This unlocks all selected files.
Delete	Deletes recorded files. Select the files, and then select Delete . This deletes all selected files, except files that are locked.
Rename	Renames a file. Enter the new name using the On-Screen Keyboard. When finished, select Done . The new name can be up to 29 characters long.
Index	When searching through a large number of media items, select a character. Media items starting with that character appear.  This is not available when View is set to Folder view .
Manage Device	Used to manage USB recording devices connected to the TV. Refer to the "Managing USB Recording Devices" section for more information.

Setting Up a Schedule Viewing

Configure the TV to show a specific channel or program at a specific time and date. The  icon appears next to programs that have been configured for a Schedule Viewing.

 To set up a Schedule Viewing, you must first set the TV's clock. Go to **Clock** (**System** > **Time** > **Clock**).

Digital Channel Schedule Viewing

You can set up **Schedule Viewing** for programs on digital channels on the following screens:

- The Guide Screen
- The Program Info Screen

The Guide Screen

To set up a scheduled viewing on the **Guide** screen, follow these steps:

1. Press the **GUIDE** button on your remote.
2. On the Guide screen, use your remote control to highlight, and then select a program you would like to view.
3. On the Information Screen that appears, select **Schedule Viewing**. The program is scheduled for viewing. The **Guide** screen re-appears.

The Program Info Screen

Recording is not supported in the U.S.A and Canada.

To set up a **Schedule Viewing** or **Schedule Recording** on the **INFO** screen, follow these steps:

1. Change the channel to the channel that will be broadcasting the program you want to schedule.
2. Press **INFO** on the standard remote. On the Samsung Smart Control, press the **KEYPAD** button, and then select the **INFO** button on the On-Screen Remote.
3. Move right to see program information for later broadcasts. The program information for the programs that will be broadcast later on that channel is displayed on the screen.
4. Highlight and then select the program you want to schedule or record. The Information screen appears.
5. Select **Schedule Viewing** or **Schedule Recording**. The program is scheduled for viewing or recording. Press the **RETURN** button on your remote.

Analog Channel Schedule Viewing

MENU > **Broadcasting** > **Schedule Manager** **Try Now**

When you set up a scheduled viewing for an analog channel, you need to know the channel, day or days of the week the program is airing, and the time the program is airing.

To set up a schedule viewing for an analog station, follow these steps:

1. Press the **MENU** button, and then select **Broadcasting** > **Schedule Manager**.
2. On the **Schedule Manager** screen, select **Schedule**. The **Schedule Viewing** screen appears.
3. On the **Schedule Viewing** screen, select the **Antenna** connection (**Air** or **Cable**), and then move to the Channel field.
 If you only receive your TV broadcasts through **Air** or **Cable**, the Antenna connection field displays only **Air** or only **Cable**.
4. Highlight the Channel field, and then select it. Scroll it up or down, find the desired channel, and then select it. Move to the Repeat field.
5. Highlight the Repeat field, and then select it. Select **Once**, **Manual**, **Sat~Sun**, **Mon~Fri**, or **Everyday**. If you select manual, you must also highlight and select the days you want.
6. Move to the Time field, and then select it. Set the hours by using the Up/Down directional buttons to move the numbers up or down. Do the same for the am/pm and minutes fields.
7. When done entering the time, press **RETURN**.
8. Select **OK** at the bottom of the **Schedule Viewing** screen.

Canceling a Schedule Viewing

To cancel a specific scheduled viewing, follow these steps:

1. Press the **MENU** button, and then select **Broadcasting** > **Schedule Manager**.
2. On the **Scheduled** screen, select the scheduled viewing. A pop-up menu appears.
3. Select **Delete** to cancel.
4. Select Yes on the "Remove this show" pop-up. The scheduled viewing is removed.

Editing a Schedule Viewing

To edit the time, days, or channel of a Schedule Viewing, follow these steps:

1. Press the **MENU** button, and then select **Broadcasting** > **Schedule Manager**.
2. On the **Scheduled** screen, select the scheduled viewing. A pop-up menu appears.
3. Select **Edit**.
4. Change the time, days, or channel in the way described in Analog Channel **Schedule Viewing**. Select **OK** when done.

Using Timeshift

This function is not available in the U.S.A. and Canada.

Timeshift lets you pause and rewind live TV as you would a DVD. Timeshift is only available for digital channels. Activating Timeshift disables the **Broadcasting** option.

- To use Timeshift, you must connect a USB recording device to the TV. Refer to the "Formatting a USB Recording Device" section for more information.
- We recommend a USB hard disk drive with a minimum speed of 5,400rpm for use with the TV's Timeshift feature. USB memory sticks are not supported.
- Read all precautions before using the Timeshift function.

Press ► while watching TV to activate the Timeshift function. The TV displays a progress bar and the following buttons at the top of the screen:

- **Information**

Displays detailed information about the current program.

 The program information may vary depending on the type of incoming signal and may not be available at all for certain programs.

 This button is only available when you are watching a live program.

- **Go to Live TV / Stop Timeshift**

Shift to live TV or exit Timeshift.

- **Pause**

Pauses the screen.

The following features are available while the screen is paused. However, there is no audio while the video is paused.

- **Step:** Select the **⏮** button, to scan through a video one frame at a time.
- **Slow Playback:** Select the **⏪ / ⏩** to play the video back at 1/4 the normal speed.

- **Rewind / Fast forward**

Repeatedly select the Rewind or Fast Forward button to speed up rewind or fast forward up to 5 times. To restore the normal playback speed, select ►.

 You cannot use **Fast forward** while watching a program that is currently being broadcast.

- **Channel List**

Displays the channel list.

- **Tools**

Launches the Tools menu.



Using the Channel List

[MENU](#) > [Broadcasting](#) > [Channel List](#) [Try Now](#)

Press and hold the **GUIDE** button while watching TV to bring up the **Channel List** and change the channel or check programs on other digital channels.

Select a channel from the **Channel List** to jump to it right away. To quickly scroll through the list, use the channel up/down buttons. This moves the focus one page at a time.

The Channel List screen contains the following icons:

-  : An analog channel
-  : A favorite channel
-  : A locked channel

- **Using Options**

Press the **<** button, and then select **Options**. The following options are available:

Function	Description
Antenna	Choose Air or Cable as the DTV mode. Air is suitable for homes equipped with separate, over-the-air antennas. Cable is suitable for homes that subscribe to a local cable-service or satellite-service provider.
Genre	Sort the list so that it includes channels of a selected genre only. You can only use Genre if you have set the channel mode in the Channel List to Added Ch. and only if the added channels contain genre information.
Edit Favorites	Designate favorite channels. Refer to the "Creating a Personal Favorites List" section for more information.



- **Viewing the Added Channels or Favorites Lists**

In the **Channel List**, press the **>** button, and then select **Added Ch.** or **Favorites**. **Favorites** will only appear if you have registered at least one favorite channel. For more information, refer to "Creating a Personal Favorites List".

Registering, Removing, and Editing Channels

[MENU](#) > [Broadcasting](#) > [Edit Channel](#) [Try Now](#)

Remove channels from the index of channels, restore removed channels, and rename analog channels. The [Edit Channel](#) screen icons indicate the following:

-  : An analog channel
-  : A favorite channel
-  : A locked channel

Registering and Removing Channels

[MENU](#) > [Broadcasting](#) > [Edit Channel](#)

Removing Registered Channels

Removing a registered channel from the channel index removes it from the list of channels you can access using the [CH,LIST](#) buttons on your remote.

1. Move the highlight to a channel, and then select it to remove it. Repeat to select additional channels.
2. To unselect a channel, move the highlight to the channel, and then select it.
3. To select all channels, select [Options](#), and then select [Select All](#) from the list. You can also select [Deselect All](#).
4. After you have made your selections, select [Delete](#).

Adding Back Removed Channels

You restore channels to the index of channels by adding them back. Removed channels are displayed in gray in the **All** list only. In addition, the **Add** option is only available for removed channels.

1. Select **Options** to display a list of options. Select **Category** from the list, and then select **All**.
2. Move the highlight to a channel you want to add. Repeat to select additional channels.
3. To unselect a channel, move the highlight to the channel, and then select it.
4. To select all channels, select **Options**, and then select **Select All** from the list. You can also select **Deselect All**.
5. After you have made your selections, select **Add**.

Editing Registered Channels

MENU > **Broadcasting** > **Edit Channel**

Select **Options** at the bottom left of the screen to access the following options. The available options may vary depending on the broadcast signal.

- **Select All**
Selects all channels displayed on the **Edit Channel** screen.
- **Antenna**
Choose **Air** or **Cable** as the DTV mode.
- **Category**
Channels stored in the TV are grouped into the following categories: **All** and **Added Ch..**
- **Edit Favorites**
Designate favorite channels. For more information, refer to "Creating a Personal Favorites List".
- **Rename Channel**
Rename analog channels. The new name can be up to 5 characters long.
- **Information**
View detailed information about the current program.

Program Rating Lock

[MENU](#) > [Broadcasting](#) > [Program Rating Lock](#)

The [Program Rating Lock](#) feature lets you block programs based on their ratings. This is useful for controlling what children watch on TV. Program Rating Lock does not block programs originating from external sources, such as Blu-ray players, DVD players, or USB files.

Every time you access the [Program Rating Lock](#) feature, you must enter the security PIN. You must also enter this PIN to watch a blocked program. The default PIN is 0000. To change the PIN, go to [System](#) > [Change PIN](#).

The [Program Rating Lock](#) is available only in [TV](#) mode.

Blocking Programs Using the TV Rating

To block content, select a rating category to lock. All programs at that level and higher are blocked and require the PIN to watch. To unblock a category, select the lock icon. To unblock all the categories in a row, select the lock under [ALL](#).

Categories on the left:

- [TV-Y](#): Young children
- [TV-Y7](#): Children 7 and over
- [TV-G](#): General audience
- [TV-PG](#): Parental guidance
- [TV-14](#): Viewers 14 and over
- [TV-MA](#): Mature audience

Categories on the top:

- [ALL](#): Lock all TV ratings.
- [FV](#): Fantasy violence
- [V](#): Violence
- [S](#): Sexual situations
- [L](#): Adult Language
- [D](#): Sexually Suggestive Dialog

Blocking based on Movie Rating (MPAA)

Block movies based on their MPAA rating. This applies to all material with supplied ratings in the USA.

From the MPAA:

“The Motion Picture Association of America (MPAA) has implemented a rating system that provides parents or guardians with advanced information on which films are appropriate for children.”

Select a lock beside one of the rating categories to block that category and all higher categories. To unblock a category, select the lock icon.

- **G**: General audience (no restrictions).
- **PG**: Parental guidance suggested.
- **PG-13**: Parents strongly cautioned.
- **R**: Restricted. Children under 17 should be accompanied by an adult.
- **NC-17**: No children under age 17.
- **X**: Adults only.
- **NR**: Not rated.

Blocking Based on Canadian English Rating

Block material based on its English Canadian rating. This applies to all rated material viewed on English-Canadian TV channels.

Select a lock beside one of the rating categories to block that category and all higher categories. To unblock a category, select the lock icon.

- **C**: Programming intended for children under age 8
- **C8+**: Programming generally considered acceptable for children 8 years and over to watch on their own
- **G**: General programming, suitable for all audiences.
- **PG**: Parental Guidance
- **14+**: Programming containing themes or content which may not be suitable for viewers under the age of 14
- **18+**: Adult programming

Blocking Based on Canadian French Rating

Block material based on its French Canadian rating. This applies to all rated material viewed on French-Canadian TV channels.

Select a lock beside one of the rating categories to block that category and all higher categories. To unblock a category, select the lock icon.

G: General

8 ans+: Programming acceptable for children 8 years and over to watch on their own

13 ans+: Programming that may not be suitable for children under the age of 13

16 ans+: Programming not suitable for children under the age of 16

18 ans+: Programming restricted to adults

Blocking Based on Downloadable U.S. Rating

Block material based on its **Downloadable U.S. Rating**. This rating system only applies to material originating from US DTV channels.

Parental restriction information is automatically downloaded while you watch DTV channels. This download may take several seconds. If the information is unavailable from the broadcasting station, the **Downloadable U.S. Rating** menu is deactivated.

Parental restriction levels differ depending on the broadcasting station. The default menu name and the **Downloadable U.S. Rating** name changes depending on the downloaded information.

Even when the on-screen display is set to another language, the **Downloadable U.S. Rating** menu appears only in English.

Select a lock beside one of the rating categories to block that category and all higher categories. To unblock a category, select the lock icon.

Watching Blocked / Restricted Programs

To watch a blocked program, enter the PIN when requested.

When initially showing a restricted program or movie, the screen is blank because the **Program Rating Lock** blocks it. Enter the PIN to unblock the program when a message appears requesting the code.

Creating a Personal Favorites List

[MENU](#) > [Broadcasting](#) > [Edit Favorites](#) [Try Now](#)

You can designate frequently watched channels as favorite channels. Favorite channels are highlighted in the [Edit Channel](#) and [Channel List](#) screens with the  symbol. You can create up to 5 favorite channel lists.

Registering Channels as a Favorites

[MENU](#) > [Broadcasting](#) > [Edit Favorites](#)

Registering the Current Channel as a Favorite

To register the current channel as a favorite:

1. While watching a TV channel, press the **TOOLS** button on the standard remote. On the Samsung Smart Control, press the **KEYPAD** button, and then select **TOOLS** on the On-Screen Remote.
2. Select **Edit Favorites** from the list.
3. In the popup window that appears, select the Favorites lists you want, and then select **OK**.

 You can select more than one Favorites list.

4. Select **OK** again. The TV has added the current channel to the Favorites list(s) you selected.

Registering Multiple Channels as Favorites

To register multiple channels as favorites at the same time:

1. Press the **MENU** button, and then select **Broadcasting** > **Edit Favorites**.
2. Select the channels that you want to add to your Favorites list(s) from the list in the screen.
3. Select **Change Fav.** on the screen.
4. Press the touch pad repeatedly on the Samsung Smart Control or the  button repeatedly on the standard remote to cycle through the Favorites list until the list you want appears.
5. Select **Add** on the screen. The TV adds the channels you selected to the Favorites list you chose.

Selecting from Favorite List Channels Only

To flip through Favorite list channels only and select a channel using the channel up/down buttons:

-  You can select a Favorites list only if it contains at least one favorite channel.
1. Press the **MENU** button, and then select **Broadcasting** > **Channel List**. The **Channel List** appears.
 2. Press the **>** button. A Favorites list appears.
 3. Press the **<** or **>** button to view other Favorites list.
 4. Highlight a channel from the selected Favorites list using the channel up/down buttons, and then select it. The channel changes.

Editing a Favorites List

[MENU](#) > [Broadcasting](#) > [Edit Favorites](#)

You can rename and edit Favorites lists.

Edit Favorites Screen Menu Items

Select [Options](#) on the [Edit Favorites](#) screen to access the following options:

- [Copy to Favorites](#)

Copy channels from one favorite channels list to another. Refer to the "Copying Channels from One Favorites list to Another" section for more information.



You can use [Copy to Favorites](#) only if you have registered one or more channels to at least one Favorites list.

- [Rename Favorites](#)

Rename an existing favorite channels list. Refer to the "Renaming a Favorites List" section for more information.



You can use Rename only if you have registered one or more channels to at least one Favorites list.

- [Antenna](#)

Choose between [Air](#) and [Cable](#).

- [Edit Channel](#)

Lets you manage the channels saved on the TV. For more information, refer to "Registering, Removing, and Editing Channels".

- [Information](#)

View detailed information about the current program.





Removing Registered Channels from a Favorites List

To remove channels from a favorite list:

1. Select **Change Fav..**
2. Press the touch pad repeatedly on the Samsung Smart Control or the  button repeatedly on the standard remote to change the Favorites list on the screen to the Favorites list you want to use.
3. Select the channels you want to remove from the selected Favorites list.
4. Select **Delete**. The channels are removed.

Rearranging a Favorites List

To rearrange the order of the channels in a favorite channels list:

1. Select **Change Fav.** at the screen.
2. Press the touch pad repeatedly on the Samsung Smart Control or the  button repeatedly on the standard remote to change the Favorites list displayed to the Favorites list you want to use.
3. In the selected Favorites list, choose the channels you want to rearrange.
 The TV will move the channels you selected as a group and rearrange them so they are displayed one after another in their new location.
4. Select **Change order**. The Change Order highlight appears highlighting the channel you chose that is closest to the top of the screen.
5. Press the / arrow buttons to relocate the channels you selected. Press the touch pad on the Samsung Smart Control or the  button on the standard remote to set the channels into their new location in the list.



Renaming a Favorites List

To rename an existing favorite channels list:

1. Select **Options** on the screen. A list of Options appears.
2. Select **Rename Favorites** from the list. A popup window appears.
3. In the popup window, select the Favorites list whose name you want to change. The on-screen keyboard appears.
4. On the keyboard, select the **Clear** button on the right. The current name displayed in the text entry field disappears.
5. Using the keyboard, enter a new name. The new name can be up to 20 characters long.
6. When finished, select **Done**. The list of favorite lists appears displaying the renamed list. Select **OK**.

Copying Channels from One Favorites list to Another

To copy channels from one favorite channels list to another:

1. Select **Change Fav.**
2. Press the touch pad repeatedly on the Samsung Smart Control or the  button repeatedly on the standard remote to change the displayed Favorites list to the Favorites list that contains the channels you want to copy.
3. Select **Options** on the screen. A list of Options appears.
4. Select **Copy to Favorites** from the list. A popup window appears.
 **Copy to Favorites** is only available if there are channels in at least one Favorites list.
5. In the popup list, select the Favorites lists you want to copy the selected channels to.
6. When done, select **OK**. The TV copies the channels. Select **OK** again.

Making Sports Programs More Realistic with Soccer Mode

[MENU](#) > [System](#) > [Soccer Mode](#)

This function is not available in the U.S.A and Canada.

Soccer Mode enables the optimal picture and sound settings for sports events, making them appear and sound as if you are there. In addition, if a recording device is connected to the TV when you are using Soccer Mode, you can use both the video recording and time shift functions at the same time while watching the sports game, as well as watching the highlights extracted from the recorded sports game automatically or manually.

 For more information about recording a program and using a recording device, refer to the "Recording Programs" section.



 For more information about the Timeshift feature, refer to the "Using Timeshift" section.

Enabling Soccer Mode

[MENU](#) > [System](#) > [Soccer Mode](#) > [Soccer Mode](#)

Go to [System](#) > [Soccer Mode](#) and then set **Soccer Mode** to **On**. The picture and sound modes of the TV are automatically optimized for sports events.

 Enabling **Soccer Mode** changes the **Picture Mode** to **Stadium** and the **Sound Mode** to **Stadium**, and disables some **Picture** and **Sound** menus.

 Press the  button to turn **Soccer Mode** on or off.

Extracting Highlights Automatically

[MENU](#) > [System](#) > [Soccer Mode](#) > [Auto Highlights](#)

Select [System](#) > [Soccer Mode](#), and then set **Auto Highlights** to **On**. You can configure the TV to extract highlights of a soccer match automatically.

However, **Auto Highlights** is not available with these TV operations:

- Switching the input signal using the **SOURCE** button.
- Launching the 3D
- When **Video Description** is set to **On**





 **Auto Highlights** performance depends on the characteristics of the transmitted signal.

 It is advisable to use **Auto Highlights** only while watching a soccer game. Using this for other sporting events may display irrelevant picture frames.

Functions Available While Watching Sports in Soccer Mode

Press the  button. The following buttons appear.

- **Zoom**

Pause the current video and select and zoom into one of the 9 blocks of the still picture. You can pan out of the zoomed-in picture using the , ,  and  buttons.

 Select or press the **A** button to launch the Zoom function easily.

 You cannot use this function when watching 3D channels or when **PIP** or **MULTIMEDIA** is active.

- **Save as Highlight**

Save a video from 10 seconds before pressing the Save as a Highlight button to 10 seconds after.

 Select or press the **B** to launch the Save as Highlight function easily.

 You can only use this function when a recording is in progress.

 You can set the TV to automatically save highlights without user intervention. Select **System** > **Soccer Mode**, and then set **Auto Highlights** to **On**.

- **Stop Recording / Go to Live TV**

When you are watching a live program, you can stop a recording by pressing this button. When you are watching a recorded program, you can switch to a live program by pressing this button.

 You can only use this function when a recording is in progress.

- **Record**

Instantly record the game you are currently watching on the TV.

 You can only use this function when the recording function is supported.

- **Rewind**

Rewind the current video. Repeatedly select this button to increase the rewind speed up to max 5 steps.

 You can only use this function when a recording is in progress.

- **Pause / Play**

Pause or resume the video.

 You can only use this function when a recording is in progress.

- **Fast forward**

Fast forward the current video. Repeatedly select this button to increase the fast forward speed up to max 5 steps.

 You can only use this function when a recording is in progress.

- **Highlight Player**

Display the **Highlight Player** screen and play the automatically or manually saved highlights in the recorded file. However, **Highlights Player** is not available with these TV operations:

- Switching the input signal using the **SOURCE** button
- Launching the 3D
- When **Video Description** is set to **On**

 You can only use this function when a recording is in progress.

- **Watch Live TV at the same time**

Watch a current program in a PIP window while watching a recorded program. To exit PIP mode, press the button again. However, **Watch Live TV at the same time** is not available with these TV operations:

- Switching the input signal using the **SOURCE** button
- Launching the 3D
- When **Video Description** is set to **On**

 You can only use this function when a recording is in progress.

 This button is only available while you are watching a recorded program.

- **Information**

View detailed information about the current program.

 This button is only available while you are watching a live program.

- **SOCIAL TV**

Launch an SNS app.

Viewing a game recorded in Soccer Mode

You can view a recorded game using the **USB Drive** option on the **MULTIMEDIA** screen.

 For more information, refer to "Viewing Recorded Programs".



 Availability depends on your specific model and area.

TV-Viewing Support Features

Showing Captions

[MENU](#) > [System](#) > [Accessibility](#) > [Caption](#) [Try Now](#)

You can watch TV broadcasts with captions.

-  Even if enabled, captions will not be displayed by programs that do not support captions.
-  Press and hold the  button on the Samsung Smart Control to turn the **Caption** function on or off.

Enabling Captions [Try Now](#)

Select [System](#) > [Accessibility](#) > [Caption](#) > [Caption](#)

-  The TV cannot control or modify DVD or Blu-ray subtitles. To control DVD or Blu-ray subtitles, use the subtitle feature of the DVD or Blu-ray player and the player's remote control.

Selecting the Caption Language [Try Now](#)

Select [System](#) > [Accessibility](#) > [Caption](#) > [Caption Mode](#) to display a list of subtitle modes. The list of modes may vary depending on the broadcast.

- [Default](#) / [CC1](#) ~ [CC4](#) / [Text1](#) ~ [Text4](#)

(Analog channels only) The analog caption function operates in either analog TV channel mode or when a signal is supplied from an external device to the TV. (Depending on the broadcast signal, the analog caption function may or may not work with digital channels.)

- [Default](#) / [Service1](#) ~ [Service6](#) / [CC1](#) ~ [CC4](#) / [Text1](#) ~ [Text4](#)

(Digital channels only) The digital caption function works with digital channels. Service1 - Service6 may not be available in digital caption mode depending on the broadcast.

Changing the Font Color, Caption Size, and Font Opacity Try Now

Change the font color, background color, and size settings.

Select **System** > **Accessibility** > **Caption** > **Digital Caption Options** and then choose the setting to change.

- **Size**

Use to change the font size. **Size** is not supported by analog channels.

- **Font Style**

Choose the font style for the subtitles.

- **Font Color**

Use to change the font color.

- **Background Color**

Use to change the caption's background color.

- **Window Color**

Use to select the color of the digital caption window.

- **Font Opacity**

Use to change the caption's opacity.

- **Background Opacity**

Use to change the background's opacity.

- **Window Opacity**

Use to select the transparency level of the digital caption window.

- **Edge Type**

Use to select outline type of the digital captions.

- **Edge Color**

Use to select the color outline of the digital captions.

- **Return to Default**

This restores all caption display options to **Default**. Setting to **Default** applies the TV station's transmitted settings.



The foreground and background color and opacity settings cannot be the same.

Enabling the Audio Guide for the Video Description

MENU > **System** > **Accessibility** > **Video Description** **Try Now**

Select **System** > **Accessibility** > **Video Description**. Activates the audio guide for the visually impaired. This function is only available with broadcasts that provide this service.

 Press and hold the  button on the Samsung Smart Control to turn **Video Description** on or off. Availability depends on your specific area.

PIP Broadcast Viewing

MENU > **Picture** > **PIP** **Try Now**

Use the PIP ("Picture-In-Picture") function to watch TV in a small window within the main screen while also watching content from a DVD player, Blu-ray player, computer, or a different external device on the main screen.

Select **Picture** > **PIP** to display the PIP settings screen. The PIP settings screen contains the following options:

- **PIP Setting**
Activates/deactivates PIP.
- **Antenna**
Choose **Air** or **Cable** as the digital channel mode.
- **Channel**
Select the PIP sub-picture channel.
- **Size**
Select the PIP sub-picture size.
- **Position**
Select the PIP sub-picture position.
- **Select Sound**
Select the audio source.

Choose a broadcast.

 You cannot use PIP while using **Smart Hub** or the **3D** function.

 Turning off the TV automatically disables PIP.



 Playing a game or using the karaoke feature on the main screen can result in lower PIP picture quality.

 For PIP to work, the main screen's source must be Component or HDMI and the input resolution must be less Full HD (FHD - 1080p). The PIP sub-screen supports digital channels only.

Scanning for Available Channels

[MENU](#) > [Broadcasting](#) > [Auto Program](#) [Try Now](#)

Automatically scans and indexes all channels received through the TV's antenna input connector.

-  Do not use this function if your TV is connected to a cable or satellite box.
 -  If the TV has saved channels, Auto Program deletes the existing list, and then saves the newly scanned channels.
1. Select [Broadcasting](#) > [Auto Program](#).
 2. Select [Start](#) when prompted. This initiates the Auto Program function. The process can take up to 30 minutes to complete.

Selecting the Broadcast Audio Language

[MENU](#) > [Broadcasting](#) > [Audio Options](#) [Try Now](#)

Configure the program's audio language. Audio Options functions differently for analog and digital channels.

-  On the Samsung Smart Control, press the [KEYPAD](#) button, and then select [INFO](#) to view the current broadcast's audio signal information. On the standard remote, press the [INFO](#) button.

Selecting the Broadcast Audio Language (Digital)



- [Selecting a Language](#) [Try Now](#)

Select [Audio Options](#) > [Preferred Language](#), and then choose a language. Digital broadcasts contain audio signals in multiple languages. Digital programs that include the language you selected in [Preferred Language](#) are automatically played using that language. If the language you selected is not supported by the broadcast signal, the TV will use the default audio language broadcast by the TV station.

Selecting the Broadcast Audio Language (Analog)

- **Listening to Multi-Track Sound** [Try Now](#)

Select **Audio Options** > **Multi-Track Sound**. Configure the audio for the current broadcast. **Multi-Track Sound** can be set to mono or stereo, depending on the broadcast signal or program. However, this option is automatically set to mono if the broadcast signal or program does not support stereo.

-  On the Samsung Smart Control, press the **KEYPAD** button, and then select **INFO** to view the current broadcast's audio signal information. On the standard remote, press the **INFO** button
-  While watching TV, press the **KEYPAD** button on the Samsung Smart Control, select **TOOLS** on the On-Screen Remote, and then select **Multi-Track Sound**. On the standard remote, press the **TOOLS** button, and then select **Multi-Track Sound**.

Fine-Tuning the Screen

MENU > **Broadcasting** > **Channel Settings** > **Fine Tune** [Try Now](#)

 Available for analog broadcasts only.

Analog pictures can become shaky and full of noise. If this happens, you can fine-tune the signal and/or reduce noise to clear up the picture.

1. Select **Broadcasting** > **Channel Settings** > **Fine Tune**. An adjustment bar appears on the screen.
2. Press the **<** or **>** button to make adjustments. Select **Save** or **Close** to apply the new setting. Select **Reset** to reset the Fine-Tune operation.

Remove Scrambled Channels

MENU > **Broadcasting** > **Channel Settings** > **Clear Scrambled Channel**

Remove scrambled channels from your auto-programmed channel list.

Changing the Picture Mode and Adjusting the Picture Quality

Choosing the Right Picture Mode for the Viewing Environment

[MENU](#) > [Picture](#) > [Picture Mode](#) [Try Now](#)

The following picture modes utilize different contrast and brightness settings to provide the best viewing experience for the environment.

 Navigate to [Edit Name](#), if you use the PC setting for PC or DVI PC, you can only available [Standard](#) and [Entertain](#).

- **Dynamic**

If the ambient lighting is too bright and makes the screen blurry, use this mode to make the picture clearer.

- **Standard**

This is the default mode suitable for most environments.

- **Natural**

This mode is useful for reducing eye strain.

- **Movie**

Appropriate for darkened rooms, for watching movies, and when experiencing eye fatigue. Darkens the screen and reduces glare.

- **Entertain**

Sharpens images for a more dynamic viewing experience.

 This mode is only available when you use a PC setting for [PC](#) or [DVI PC](#) on [Edit Name](#).

Adjusting the Picture Quality for Each Picture Mode

MENU > Picture

Select one of the settings below from the **Picture** menu to display the slide bar for the selected setting. Adjust the value by pressing the < or > button on your remote. Choose a different setting by pressing the ^ or v button. Adjusted values are applied to the current source and picture mode.

 The **Color** and **Tint (G/R)** settings cannot be adjusted when the TV is connected to a computer via an HDMI to DVI cable.

Choose a **Picture Mode** - **Dynamic**, **Standard**, **Natural**, **Movie** - and then adjust the settings.

- **Backlight** [Try Now](#)

Adjusts the brightness of individual pixels. Decreasing the brightness reduces power consumption.

- **Contrast** [Try Now](#)

Adjusts the screen contrast.

- **Brightness** [Try Now](#)

Adjusts the overall brightness.

- **Sharpness** [Try Now](#)

Sharpens or dulls the edges of objects.

- **Color** [Try Now](#)

Adjusts the overall color saturation.

- **Tint (G/R)** [Try Now](#)

Adjusts the ratio of green to red. Increase the green value to saturate the greens and the red value to saturate the reds.

 Adjusted values are saved by the TV for the current source and picture mode, and remain in effect each time the source and picture mode is selected. Consequently, the TV can have different picture settings for each external source.

Applying the Current Picture Settings to Other Input Sources [Try Now](#)

MENU > Picture > Apply Picture Mode



You can apply the picture quality setting that you configured for the TV to all external devices connected to the TV or to the current source only.

To apply the setting to all external devices connected to the TV, select **All Sources**. To apply the setting to the current input only, select **Current Source**.

Fine-Tuning Each Picture Mode (Advanced Settings)

MENU > Picture > Advanced Settings [Try Now](#)

Select **Picture > Advanced Settings** to fine-tune how images are displayed on the TV screen for each **Picture Mode**.

-  **Advanced Settings** is only available when the **Picture Mode** is set to **Standard** or **Movie**.
-  When the TV is connected to a computer via an HDMI-DVI cable, only **White Balance** and **Gamma** can be adjusted.

Choose a **Picture Mode** and then adjust the settings.

- **Dynamic Contrast** [Try Now](#)
Automatically adjusts the screen contrast. Use this option to achieve the optimal contrast setting.
- **Black Tone** [Try Now](#)
Adjusts the black color depth.
- **Flesh Tone** [Try Now](#)
Darkens or lightens skin tones.
- **RGB Only Mode** [Try Now](#)
Adjusts the red, green, and blue levels individually.

- **Color Space** [Try Now](#)

Adjusts the range of colors (the color space) that the TV can display. **Auto** automatically adjusts the color space depending on the input signal. **Native** applies a range that is wider than the input signal. **Custom** allows you to adjust the color space manually.

- **White Balance** [Try Now](#)

You can adjust the color temperature of the picture to make white objects look white, and the overall picture appear natural.

2 Point: Lets you adjust red, green, and blue luminosity with the offset menu and brightness with the gain menu. To restore the default values, select **Reset**.

10 Point: Divides red, green, and blue into 10 sections each, and lets you modify the white balance by adjusting the brightness of each section. Select the section to adjust in the **Level** field.

 You can use the **10 Point** function only when the **Picture Mode** is set to **Movie**. Some external devices may not support this function.

- **Gamma** [Try Now](#)

Adjusts the primary color intensity.

- **Motion Lighting** [Try Now](#)

Adjusts the brightness in response to on-screen movements to reduce power consumption.

 This feature is only available when the **Picture Mode** is set to **Standard** and is not available in 3D mode.

 Adjusting the **Contrast**, **Brightness**, and other picture quality settings deactivates **Motion Lighting**.

Adjusting the Picture for Easier Viewing (Picture Options)

[MENU](#) > [Picture](#) > [Picture Options](#) [Try Now](#)

Select [Picture](#) > [Picture Options](#) to make additional adjustments for a better viewing experience.

 When the TV is connected to a computer via an HDMI-DVI cable, only [Color Tone](#) can be adjusted.

Choose a [Picture Mode](#) and then adjust the settings.

- [Color Tone](#) [Try Now](#)

Adjusts the color tone. The setting is applied on an individual [Picture Mode](#) basis. When you select a new [Picture Mode](#), the TV applies the Color Tone you selected for that mode automatically.

 If the [Picture Mode](#) is set to [Dynamic](#), you will only be able to choose [Cool](#) or [Standard](#).

- [Digital Clean View](#) [Try Now](#)

Reduces static and ghosting caused by a weak signal. Selecting [Auto Visualization](#) displays the signal strength on the screen. Green indicates the best possible signal.

 This function is only available for analog channels.

- [MPEG Noise Filter](#) [Try Now](#)

Reduces MPEG noise and improves video quality.

- [HDMI Black Level](#) [Try Now](#)

Some external devices connected to the TV via an HDMI cable can have issues such as low black level, low contrast, and dull colors. Use HDMI Black Level to adjust the black level to compensate.

 This is only available when the Input Signal, connected to the TV via an HDMI connector, is set to RGB444.

- **Film Mode** [Try Now](#)

Optimizes the picture quality for movies. Select this mode for watching movies.

 This feature is only available when you are watching a TV broadcast or when the input signal is AV, Component (480i, 1080i), or HDMI (1080i).

- **Auto Motion Plus** [Try Now](#)

Removes blurring and judder from scenes with rapid movement. If you select **Custom**, you can configure Blur Reduction and Judder Reduction manually and set **LED Clear Motion** on for a sharper LED image.

 If you have **Auto Motion Plus** on, and then bring up the **INFO** screen, the **INFO** screen displays the resolution and frequency of the incoming video signal (60Hz). This frequency is not the same as the frequency of the picture the TV is displaying when **Auto Motion Plus** is on.

 If **LED Clear Motion** is **On** at 60Hz video signal, the screen may flicker.



- **Cinema Black** [Try Now](#)

In Movie mode, this feature dims the upper and lower zones of the video image to provide a more immersive viewing experience.

Viewing in 3D

[MENU](#) > [Picture](#) > [3D](#) [Try Now](#)

The 3D option lets you view 3D media content and broadcasts. You will need to wear Samsung 3D Active Glasses to play 3D content. IR-type Samsung 3D Active Glasses and third-party 3D glasses are not supported.

-  Carefully read the health and safety information concerning 3D viewing before viewing 3D content. Refer to the "3D Precautions" section for more information.
-  Whether 3D video is displayed in true HD is usually determined by the quality and format of the video.

Starting 3D

1. Press the **3D** button on your remote control or select the 3D On-Screen Remote.
2. Play 3D content.
3. Put on the Samsung 3D glasses, and then turn the glasses on. 3D viewing is enabled.

The ideal viewing distance is three times the height of the screen or more. 3D images may not appear if you do not adhere to the recommended viewing angle or distance.

The 3D feature may not work properly if there is another 3D product or an electronic device running nearby. If there is a problem, keep other electronic devices as far away as possible from the 3D Active Glasses.

The left and right 3D images may initially overlap when the TV is turned on. It takes a moment for the display to optimize and the overlapping to stop.

There are several restrictions when using 3D TV:

- Launching Smart Hub automatically disables 3D mode.
- **PIP** cannot be used.
- Certain **Picture** options are disabled.

Changing the 3D Mode

MENU > Picture > 3D > 3D Mode [Try Now](#)

1. Press the **3D** button on your remote to start the 3D function, and then select **3D Mode** under **Picture > 3D**.
2. Choose from the 3D modes that appear on the screen. The supported 3D Modes may vary depending on the 3D content.

 **3D Mode** is automatically configured for most 3D content.

The following 3D Modes are available. However, mode availability may vary depending on the 3D content's format.

 The supported resolutions vary for each mode. Refer to the "Supported Resolutions for 3D Modes" section for more information.

-  (Off)

Deactivates 3D viewing.

-  (Normal)

Converts normal images to 3D images.

 Some formats do not support this mode.

-  (L/R)

Splits a single image into left and right overlapping images to create the 3D effect.

-  (T/B)

Splits a single image into top and bottom overlapping images to create the 3D effect.

-  (Horizontal Line)

Switches between left and right images one horizontal line at a time.

-  (Vertical Line)

Switches between left and right images one vertical line at a time.





-  (Pixel)



Switches between left and right images one pixel at a time.

-  (Frame)

Switches between left and right images one frame at a time.

When the TV is connected to a computer:

  (Horizontal Line),  (Vertical Line), and  (Pixel) settings can only be selected when the computer's resolution is set to 1920x1800, or the computer is connected to the TV via an HDMI-DVI cable.

  (Frame) setting can only be selected when the computer's resolution is set to 1920x1080 and the frequency to 60Hz.

Adjusting the 3D Effect

MENU > Picture > 3D

Configure the viewpoint, depth, and other 3D settings for a custom viewing experience.

 All 3D effects with the exception of **3D Auto View** can only be used while watching 3D content.

- **Adjusting the 3D Viewpoint** [Try Now](#)

Select **Picture > 3D > 3D Perspective**. Use the adjustment bar shown on the screen to adjust the viewpoint.

- **Adjusting the 3D Depth** [Try Now](#)

Select **Picture > 3D > Depth**. Use the adjustment bar shown on the screen to adjust the depth.

 This option cannot be used if 3D mode is set to  (L/R) or  (T/B).

- **Reversing the Left/Right 3D Images** [Try Now](#)

Select **Picture > 3D > L/R Change**. Use to reverse the left and right images.

- **Displaying 3D Content in 2D** [Try Now](#)

Select **Picture > 3D > 3D → 2D**. Use to enable 2D viewing of 3D content.

 This function is not available if 3D mode is set to  (Normal) or  (Off).

- **Automatically Turning on 3D if 3d Content is Detected**

Select **Picture > 3D > 3D Auto View**. Use 3D Auto View to set the TV to activate 3D mode automatically when 3D content or a 3D broadcast is detected.

If **3D Auto View** is set to **Message Notice**, a window confirming 3D activation will be displayed. 3D is activated once confirmed.

 3D is not displayed while certain applications are running. To watch the TV in 3D mode, exit the application.

- **Adjusting 3D Brightness**

Select **Picture > 3D > 3D Light Control**. Adjust the 3D brightness level. If the screen is too dark, select **High**.

Picture Support Functions

PIP Broadcast Viewing





[MENU](#) > [Picture](#) > [PIP](#) [Try Now](#)

Watch video from an external device such as a Blu-ray player on the main screen while viewing a TV broadcast in a picture-in-picture window.

Select [Picture](#) > [PIP](#) to display the PIP settings window. The PIP settings window contains the following options:

- **PIP**
Activates/deactivates PIP.
- **Antenna**
Choose [Air](#) or [Cable](#) as the input source for the PIP sub-picture window.
- **Channel**
Selects the PIP sub-picture channel.
- **Size**
Selects the PIP sub-picture size.
- **Position**
Selects the PIP sub-picture position.
- **Select Sound**
Selects the audio source.

Choose a broadcast.

-  PIP cannot be used while [Smart Hub](#) or [3D](#) is active.
-  Turning off the TV automatically disables PIP.
-  Playing a game or using the karaoke feature on the main screen can result in a lower PIP picture quality.
-  For PIP to work, the main screen's source must be Component or HDMI and the input resolution must be less than FHD (Full HD). The PIP sub-screen supports digital channels only.

Changing the Picture Size and Position

Choosing the Right Screen Size [Try Now](#)

[MENU](#) > [Picture](#) > [Picture Size](#) > [Picture Size](#)

Most TV programs and videos are displayed in full screen, but some programs and videos are displayed in sizes that are larger or smaller. You can change the screen size for such programs and videos so that the picture fits the screen better.

 Supported screen sizes vary depending on the input signal. Refer to the "Picture Sizes and Input Signals" section for more information about supported screen sizes.

- **16:9**

Set the picture to the 16:9 wide-screen format.

- **Zoom1**

Magnify 16:9 pictures vertically. A magnified picture can be moved up and down.

- **Zoom2**

Magnify Zoom1 picture even more. A magnified picture can be moved up and down.

- **Wide Fit**

Enlarge the aspect ratio of the picture so it fits the entire screen. Enjoy 4:3 images as undistorted 16:9 images.

- **4:3**

Sets the picture to basic 4:3 mode.

- **Screen Fit**

Displays the full image without any cutoff.

- **Smart View 1**

Reduces a 16:9 picture by 50%.

- **Smart View 2**

Reduces a 16:9 picture by 25%.

Adjusting the Screen Position [Try Now](#)

[MENU](#) > [Picture](#) > [Picture Size](#) > [Position](#)

Adjusts the screen position.

-  This option is only available with **Size** set to **Zoom1**, **Zoom2**, **Wide Fit**, or **Screen Fit**. When the TV is tuned to a digital channel, the screen position cannot be adjusted if the **Picture Size** is set to **Screen Fit**.
1. To adjust the screen's position, select **Picture** > **Picture Size** > **Position**. A popup window appears.
 2. Select **Position** again from the popup window.
 3. Press the **^**, **v**, **<** or **>** button to move the screen. When done, select **Position** and then **Close**. Select **Reset** to reset the screen position.

Listening to Audio Only with the Screen Turned Off (Picture Off)

[MENU](#) > [Picture](#) > [Picture Off](#) [Try Now](#)

Turns off the screen and plays audio through the speakers only. To turn the screen back on, press any button other than the power and volume buttons.

Resetting the Picture Mode Settings

[MENU](#) > [Picture](#) > [Reset Picture](#) [Try Now](#)

Use this option to reset the current **Picture Mode** to its factory settings. This does not affect the settings of other Picture Modes.

Changing the Sound Mode and Using Sound Effects

Choosing the Right Sound Mode for the Environment

[MENU](#) > [Sound](#) > [Sound Mode](#) [Try Now](#)

Sound modes apply preset adjustments to the sound output, optimized for different viewing and listening circumstances.

 The sound modes cannot be used when you are listening to audio through external speakers.

- **Standard**

This is the normal sound mode.

- **Music**

This mode emphasizes normal music instead of voices.

- **Movie**

This mode is calibrated to provide the best sound for movies.

- **Clear Voice**

This mode emphasizes voices.

- **Amplify**

This mode increases the overall intensity of high-frequency sounds for a better listening experience. It is designed for hearing-impaired listeners.

Using Sound Effects

[MENU](#) > [Sound](#) > [Sound Effect](#) [Try Now](#)

Use sound effects to alter how the TV projects sound.

 Sound effects can only be used if the **Sound Mode** is set to **Standard**.

 The sound effects cannot be used when you are listening to audio through external speakers.

Choose a **Sound Effect** and then adjust the settings.

- **Virtual Surround** [Try Now](#)

Produces sound that will make you feel like you are sitting in a movie theater or concert hall.

- **Dialog Clarity** [Try Now](#)

Increases voice intensity to make dialog clearer.

- **Equalizer** [Try Now](#)

Lets you adjust the speaker balance and make bandwidth adjustments. Select **Reset** to reset the settings.

Customizing Sound (Sound Customizer)

[MENU](#) > [Sound](#) > [Sound Customizer](#) [Try Now](#)

Sound Customizer lets you calibrate the TV for optimal sound quality based on your hearing capabilities and the ambient conditions.

Customizing Sound

[MENU](#) > [Sound](#) > [Sound Customizer](#) > [Add Custom Sound](#) [Try Now](#)

1. Select **Add Custom Sound**.
2. On the **Add Custom Sound** screen, read the instructions, and then select **Start**.
3. Select **Preview**, listen to the Preview tone, and then select **Next**.
4. A 6-step test will start. During each stage, the TV will sound a test tone at a different frequency. The tone will begin softly and increase in volume. Select **Yes** when you can hear the test tone. If you want to listen to it again, select **No**. Once the test is complete, a screen appears that lets you compare the original sound to the calibrated sound.
5. Select **Next**. The on-screen keyboard appears with a default profile name. Enter a name for the calibrated sound profile or accept the default name, and then select **Done**.
6. Select **OK** on the next screen. The **Sound Customizer** screen reappears.

You can create additional profiles by selecting Add Custom Sound on the Sound Customizer screen, and then following the instructions above from Step 2.

Using a Custom Sound Profile

[MENU](#) > [Sound](#) > [Sound Customizer](#) > [Custom Sound Profile](#) [Try Now](#)

If there are multiple Custom Sounds, simply choose the one you want to use.

1. Select **Sound** > **Sound Customizer** > **Custom Sound Profile**.
2. Select a **Custom Sound Profile** from the list.

Renaming and Deleting Custom Sound Profiles

MENU > **Sound** > **Sound Customizer** > **Manage Custom Sound** **Try Now**

Rename or delete custom sound profiles.

-  To use **Manage Custom Sound**, you must have a **Custom Sound Profile** in the **Custom Sound Profile** list.
1. Select **Sound** > **Sound Customizer** > **Custom Sound Profile**.
 2. Choose a Custom Sound Profile you want to rename or delete.
 3. Select **Sound** > **Sound Customizer** > **Manage Custom Sound**. This brings up the **Manage Custom Sound** window.
 4. Select a **Custom Sound Profile** you want to rename or delete, and then select **Rename** or **Delete**. Selecting **Rename** brings up the on-screen keyboard. Use the keyboard to change the name. **Delete** deletes the selected **Custom Sound Profile**.

Modifying a Custom Sound

MENU > **Sound** > **Sound Customizer** > **Edit Custom Sound** **Try Now**

Modify the sound settings of a Custom Sound profile.

1. Select **Sound** > **Sound Customizer** > **Edit Custom Sound**, and then select the Custom Sound you want to edit from the popup window.
2. Select **Preview** to listen to the preview test tone, and then select **Next**.
3. A 6-step test will start. During each stage, select **Yes** when you can hear the test tone. If you want to listen to it again, select **No**. Once the test is complete, you can compare the original to the calibrated sound.
4. Select **Next**, and then enter a name for the calibrated sound profile.
5. When finished, select **Done**.

Sound Support Functions

Selecting Speakers

[MENU](#) > [Sound](#) > [Speaker Settings](#) > [TV Sound Output](#) [Try Now](#)

TV Sound Output lets you choose which speakers the TV uses for audio output. Select [Sound](#) > [Speaker Settings](#) > [TV Sound Output](#) and then select the speakers from the list. To listen to audio through the TV's speakers and the speakers of a connected AV receiver or home theater simultaneously, select [TV Speaker](#). If this causes an echo effect, choose any speaker option other than [TV Speaker](#) to mute the TV speakers, or turn off the receiver or home theater.

 Using external speakers alone disables the volume button and the mute function. In addition, certain [Sound](#) options are also disabled.

- [TV Speaker](#)

Listen to the TV's audio through the TV's internal speakers.

- [Audio Out](#)

Listen to the TV's audio through headphones or through the speakers of a device connected to the TV via a digital optical cable.

- [Receiver](#)

Listen to the TV's audio through the speakers of a home theater or receiver connected to the TV via HDMI.

- [TV Sound Connect](#)

Listen to the TV's audio through the speakers of a Bluetooth device connected to the TV.

- [Multiroom Link](#)

Listen to the TV's audio through the speakers of a device connected to the TV wirelessly.

Designating the TV's Installation Type

[MENU](#) > [Sound](#) > [Speaker Settings](#) > [TV Installation Type](#)

Specify the TV's installation type. Choose between [Wall Mount](#) and [Stand](#) to optimize the TV's sound automatically.

Listening to TV Sound through Samsung Bluetooth or Wi-Fi Audio

[MENU](#) > [Sound](#) > [Speaker Settings](#) > [TV SoundConnect](#)

Connect the TV to a Samsung audio device for a richer, clearer sound.



This option is only available for Samsung audio devices that support TV SoundConnect.



You can't use Bluetooth headphones, TV SoundConnect and Surround features simultaneously.

Pair the Samsung audio device using the TV's Bluetooth or Wi-Fi function. Refer to the Samsung audio device's operating manual for more information on pairing.



When listening to TV audio through a Samsung audio device, certain types of content may produce video-to-audio syncing issues.

- [Samsung Audio Device List](#)

Displays a list of paired Samsung audio devices. Select a device to display its menu options. You can activate/deactivate the audio device or remove it from the list.

- [Add New Device](#)







Lets you add new devices to the list of paired devices. The connection signals from new devices are ignored if [Add New Device](#) is set to [Off](#).

Listening to TV Sound through Samsung Multiroom Link compatible Speakers

[MENU](#) > [Sound](#) > [Speaker Settings](#) > [Multiroom Link](#)



Availability depends on the specific model.

Configure this product for connection to a Samsung Multiroom Link compatible speaker and enjoy rich sound.

-  To use this feature, at least one Samsung Multiroom Link compatible speaker must be connected.
-  Sound quality may be affected by the condition of the wireless network.
-  Network connection status can be negatively influenced and even can be lost, if the network environment getting worse by time.
-  For further details, refer to the Multiroom Link manual from the web site, (www.samsung.com > SUPPORT > Firmware Manuals & Downloads)
-  The audio from each device may lag behind the video and audio of the device which is playing the source contents.
-  While playing the [Multi-Link Screen](#), you can hear the selected audio.
-  Activating [Screen Mirroring](#) disables [Multiroom Link](#).

- **Settings**

Set the configuration of of Samsung Multiroom Link compatible speaker(s) you connected to the TV.

-  Audio and visual sync mismatches may occur, depending on the model.
-  Network speakers can disconnect depending on the network environment.
-  While playing the [Multi-Link Screen](#), you can hear the selected audio.

- **Surround**

Set numbers of Samsung Multiroom Link compatible speaker(s) in a space and enjoy surround system.

- **Multiroom**

Configure the network speakers so that all play the same, combined audio. Channels are ignored.

- **SoundBar+Surround**

If you have connected a Sound Bar, set [SoundBar+Surround](#) to rear speakers. The Sound Bar already includes the Center and Front Left and Right channels.

-  Activating [Screen Mirroring](#) disables [Multiroom Link](#).

- **Volume Level**

Adjust the volume of each speaker individually or all speakers at once.

- **Speaker Test**

Send a test sound to each speaker to make sure your system is working properly.

- **Edit Name**

You can give each speaker a name.

Enabling Digital Audio Output

[MENU](#) > [Sound](#) > [Additional Settings](#) [Try Now](#)

This Smart TV is SPDIF-enabled. The Sony Philips Digital Interface (SPDIF) provides digital audio output to speakers and various digital devices, including A/V Receivers and home theaters.

- [Audio Format](#) [Try Now](#)

Selects the Digital Audio output (SPDIF) format. The available Digital Audio output (SPDIF) formats may vary depending on the input source.

- [Audio Delay](#) [Try Now](#)

This setting helps correct timing mismatches between the audio and video tracks when you are watching TV and listening to audio through a digital audio device. Enabling the feature displays a slide bar that you can use to adjust the delay by up to 250ms.

- [Dolby Digital Comp](#) [Try Now](#)

Set Dolby Digital compression mode.

- [Auto Volume](#) [Try Now](#)

When you change channels, video sources, or content, [Auto Volume](#) automatically adjusts the TV's volume level so that the volume level remains the same for all sources. For example, if you switch from a streaming video application to a Blu-ray player or a favorite TV channel, [Auto Volume](#) can modify the volume up to 12db to equalize the sound.

The [Auto Volume](#) function has two settings: [Normal](#) and [Night](#). [Normal](#) applies a normal level of volume adjustment. [Night](#) applies a slightly lower volume level and is ideal for late-night TV viewing. If you want to use the volume control of a connected source device to control the sound, deactivate the [Auto Volume](#) function. When you use the [Auto Volume](#) function with a source device, the device's volume control may not function properly.

Listening to 3D Audio in 3D Mode

[MENU](#) > [Sound](#) > [3D Audio](#) [Try Now](#)

3D audio technology provides immersive sound that matches the pop-up effect of 3D video by using perspective in the audio depth control.

 This function is only available in 3D mode.

Resetting All Sound Settings

[MENU](#) > [Sound](#) > [Reset Sound](#) [Try Now](#)

Use to reset all sound settings to the factory defaults.

Setting the Time and Using the Timer

Setting the Current Time

[MENU](#) > [System](#) > [Time](#) > [Clock](#) [Try Now](#)

Set the clock manually or automatically.

To view the time after the clock is set:

- **Samsung Smart Control:** Select the **INFO** button on the On-Screen Remote. ([KEYPAD](#) > **INFO**)
- **Standard Remote:** Press the **Info** button.

 The clock must be reset every time the power is disconnected.

Setting the Clock using Digital Broadcast Info



[MENU](#) > [System](#) > [Time](#) > [Clock](#) > [Clock Mode](#) [Try Now](#)

Set **Clock Mode** to **Auto**. The TV automatically downloads the correct time from a digital channel. To enable this option, the TV's Antenna jack must be connected to either an antenna or a cable output and must be receiving digital broadcasts. The accuracy of the time information received may vary depending on the channel and signal. If your TV is connected to a set-top-box or satellite box using HDMI or Component connections, you must set the time manually.

If the Clock is Wrong in Auto Mode...

MENU > **System** > **Time** > **Clock** > **Time Offset** **Try Now**

If the time set automatically is incorrect, you can offset the clock in 1-hour increments by as much as +/- 12 hours. Select **System** > **Time** > **Clock** > **Time Offset**, and then offset the clock to the correct time.

-  **Time Offset** adjusts the time through a network connection and is only available if the **Clock Mode** is set to **Auto** and the TV is connected to the Internet through a local area network.
-  **Time Offset** adjusts the time if the TV fails to receive time information through normal digital broadcast signals.

Setting the Clock Manually

MENU > **System** > **Time** > **Clock** > **Clock Set** **Try Now**

To enter the time and date manually, follow these steps.

1. Set **Clock Mode** to **Manual**, and then select **Clock Set**.
2. Select **Date**. The date entry pop-up appears.
3. Use the **^** and **v** buttons to change the month. When done, move to the date field and then the year field and set them in the same fashion. When done, press the **RETURN** button on your remote.
4. Select the **Time** field. Use the **^** and **v** buttons to set the hour.
5. When done, move to the minutes field and then the am/pm field and set them in the same fashion. When done, press the **RETURN** button on your remote.

Using the Timers

Using the Sleep Timer

[MENU](#) > [System](#) > [Time](#) > [Sleep Timer](#) [Try Now](#)

This function automatically shuts off the TV after a preconfigured period of time. Select [System](#) > [Time](#) > [Sleep Timer](#). You can set the timer up to 180 minutes in 30-minute increments.

Turning On the TV using On Timer

[MENU](#) > [System](#) > [Time](#) > [On Timer](#) [Try Now](#)

Set the [On Timer](#) so that the TV turns on automatically at a chosen time. You can set up three separate [On Timer](#) configurations concurrently: [On Timer 1](#), [On Timer 2](#), and [On Timer 3](#). The On Timer is only available if the [Clock](#) has been set.

- [Setup](#)

Select [Off](#), [Everyday](#), [Mon~Fri](#), [Sat~Sun](#), or [Manual](#). If you select [Manual](#), you can select the days you want the [On Timer](#) to turn on the TV by highlighting each day, and selecting it.

- [Time](#)

Set the time that the TV turns on automatically. See [Manual](#) under Setting the Time for time setting instructions.

- [Volume](#)

Specify the volume the TV will set itself to when it turns on.

- [Source](#)

Select a signal source from the list. This is the source the TV will access when it turns on. If you want to use a USB device, that USB device must be connected to the TV before you start the On Timer set up. To play back media from an HDMI or Component source such as a DVD player, Blu-ray player, or set-top-box, you must leave the device on. It must be on and playing when the TV turns on.

- [Antenna](#)

If you have set the [Source](#) to [TV](#), select a broadcast signal source, [Air](#) or [Cable](#).



- [Channel](#)

If you have set the [Source](#) to [TV](#), select a channel.

- [Music / Photo](#)

If you have set the [Source](#) to [USB](#), specify a USB device folder containing music files in the music field and/or a folder containing photos in the photo field. If you select a folder that contains music files and a folder that contains photo files, the TV plays the music files and displays the photos at the same time.

To select (for example) a music folder, follow these steps:

1. Select the music field. The music screen appears.
2. If you have no folders in the USB drive and all your music files are in the root directory, highlight, and then select the Select button. The USB drive is selected and the On Timer screen reappears displaying the name of the USB drive in the music field.
3. If you have folders with music on the USB drive, press the touch pad on the Samsung Smart Control or the  button on the standard remote. The TV displays all the folders on the drive.
4. Scroll the list of folders until the folder you want appears. Move the highlight to the Select button to the right of the folder. Press the touch pad. On a standard remote, press and hold the  button. The **On Timer** screen reappears displaying the folder name in the music field.

 If the folder you choose has sub-folders, you can select a sub-folder in the same fashion.

5. If you want, select a photo folder in the same way. Start by selecting the photo field.

 This feature will not function properly if the selected USB device does not contain media files or a folder has not been specified.

 The slideshow will not start if there is only one image file on the USB device.

 Folders with long names cannot be selected.

 Always use different folder names for multiple USB devices.

 Use a USB memory stick or multi-card reader. The **On Timer** may not work with certain battery-powered USB devices, MP3 players, or PMPs because the TV may take too long to recognize the device.

Turning Off the TV Using the Off Timer

MENU > **System** > **Time** > **Off Timer** [Try Now](#)

Set the **Off Timer** to turn the TV off automatically at a specific time. You can set up three separate Off Timer configurations concurrently: **Off Timer 1**, **Off Timer 2**, and **Off Timer 3**. The Off Timer is available only if the **Clock** has been set.

- **Setup**

Select **Off**, **Everyday**, **Mon~Fri**, **Sat~Sun**, or **Manual**. If you select **Manual**, you can select the days you want the **Off Timer** to turn off the TV by highlighting each day, and then selecting it.

- **Time**

Set the time that the TV turns off automatically.

Using the Screen Burn Protection and Energy Saving Features

Preventing Screen Burn

[MENU](#) > [System](#) > [Auto Protection Time](#) [Try Now](#)

Still images can leave burned-in after-images on the screen if left on the screen for a long period of time. Use Screen Burn Protection to protect the screen. Select [System](#) > [Auto Protection Time](#) and then choose a time setting from the list. If a still image is shown on the screen for longer than the time you selected, the TV will automatically activate the Screen Burn Protection function to prevent burnt-in after-images.

Using Energy Saving Features

[MENU](#) > [System](#) > [Eco Solution](#) [Try Now](#)

Eco Solution adjusts the TV's brightness level and prevents overheating to reduce overall power consumption.

- [Energy Saving](#) [Try Now](#)

Select a brightness setting from the list to reduce the TV's power consumption.

- [Eco Sensor](#) [Try Now](#)

Automatically adjusts the TV's brightness level based on the ambient light level to reduce the TV's power consumption. If the Eco Sensor has adjusted the screen's brightness level, you can manually adjust the screen's minimum brightness level by adjusting the [Min. Backlight](#) or [Min Cell Light](#) (in applicable models). Changing the [Backlight](#) or [Min Cell Light](#) setting (in applicable models) while [Eco Sensor](#) is running automatically disables [Eco Sensor](#).

- [No Signal Power Off](#) [Try Now](#)









Select a time from the list. If no signal is received for the specified duration, the TV will automatically cut off the power to reduce power consumption.

- [Auto Power Off](#) [Try Now](#)

If the TV remains on for four hours without any user input, the TV will automatically turn off to prevent overheating.

Using Anynet+ (HDMI-CEC)

Use Anynet+ (HDMI-CEC) to control all external devices that support HDMI-CEC using just the TV's remote control. Note that Anynet+ (HDMI-CEC) only works with the TV's remote control and not with the panel keys.

-  You can configure the TV's universal remote function to control - using the TV's remote control - third-party cable boxes, Blu-ray players, and home theaters that do not support HDMI-CEC. Refer to the "Controlling External Devices with the TV Remote - Using the Universal Remote" section for more information.
-  Anynet+ cannot be used to control external devices that do not support HDMI-CEC.
-  Anynet+ devices must be connected to the TV using an HDMI cable. Some HDMI cables may not support Anynet+ (HDMI-CEC). In this case, you will need to replace the HDMI cable.
-  The TV remote control may not function under certain circumstances. If this occurs, select the Anynet+ device again.
-  Anynet+ (HDMI-CEC) only works with external devices that support HDMI-CEC and only when those devices are either in standby mode or turned on.
-  Anynet+ (HDMI-CEC) can control up to 12 compatible external devices (up to 3 of the same type). With home theater systems, however, the number of systems that can be controlled is limited to one.
-  To listen to 5.1-channel audio from an external device, connect the device to the TV via an HDMI cable and the device's digital audio output connector directly to the home theater system.
-  A home theater system that has been connected to the TV using an HDMI cable and an optical cable supports 2-channel audio only. 5.1-channel audio is, however, available for digital broadcasts with 5.1-channel audio.

Setting Up Anynet+ (HDMI-CEC)

[MENU](#) > [System](#) > [Anynet+ \(HDMI-CEC\)](#) [Try Now](#)

- [Anynet+ \(HDMI-CEC\)](#) [Try Now](#)

Enables/disables Anynet+ (HDMI-CEC). Set to **Off** to disable all Anynet+ related features. Set to **On** to enable all Anynet+ related features.

- [Auto Turn Off](#) [Try Now](#)

When set to **Yes**, turns off Anynet + compatible external devices when the TV is turned off.

 Some Anynet + compatible devices do not support this feature.

- [Device search](#) [Try Now](#)

Automatically search for and identify Anynet+ (HDMI-CEC) compatible external devices that are connected to the TV.

Using Anynet+ (HDMI-CEC)

Selecting an External Device

1. On the Samsung Smart Control, press the **KEYPAD** button, and then select **TOOLS** on the On-Screen Remote. On a standard remote, press the **TOOLS** button. The **Tools** list appears.
2. Select **Anynet+ (HDMI-CEC)** from the list. The **Select Device** screen appears.
3. Select a device and wait for the switch to take place. This process may take up to 2 minutes to complete and cannot be cancelled once started.

Accessing the External Device's Menu

Once the TV has switched over to the selected device, you can access the device's menu using the TV's remote control.

1. On the Samsung Smart Control, press the **KEYPAD** button, and then select **TOOLS** on the On-Screen Remote. On a standard remote, press the **TOOLS** button. The **Tools** list appears.
2. Select **Anynet+ (HDMI-CEC)** from the list. The following list appears.

 The menu options available in **Tools** may differ depending on the external device.

- **Anynet+ (HDMI-CEC)**

Displays a list of HDMI-CEC-compliant devices connected to the TV. Select **View TV** to exit Anynet+ (HDMI-CEC), and start watching TV. To switch to the screen of an external device, simply select that respective device.

- (Connected Device) **Menu**

Display the menu of the connected device. If the target device is a DVD player, the DVD player's menu is shown.

- (Connected Device) **Tools**

Displays a list of frequently-used functions available for the device. If the target device is a DVD player, the DVD player's playback menu is shown.

 Some external devices may not support this option.

- (Connected Device) **Title Menu**

Displays the title menu of the disc in the connected device. For example, if the target device is a Blu-ray player, the title menu of the disc in the player is shown.

 Some external devices may not support this option.

Updating the TV's Software

[MENU](#) > [Support](#) > [Software Update](#) [Try Now](#)

View your TV's software version and update it if necessary.

The TV is set to update software automatically via the internet by default. If you don't want to update it automatically, set [Auto Update](#) ([Support](#) > [Software Update](#) > [Auto Update](#)) to **Off**.

⚠ DO NOT turn off the TV's power until the update is complete. The TV will turn off and on automatically after completing the software update. All video and audio settings return to the default settings after a software update.

Update now

[MENU](#) > [Support](#) > [Software Update](#) > [Update now](#) [Try Now](#)

[Update now](#) lets you update your TV's software in three ways:

- Online, by downloading the update from the Internet directly to your TV.
- Manually, using a USB flash drive.
- Automatically (Auto Update), while the TV is in Standby Mode.

Each method is explained below.

Online

To update your TV using the Online method, follow these steps:

1. Make sure that your TV is connected to your local network and the Internet. The connection can be wired or wireless.
2. All video and audio settings return to their default settings after a software update. We recommend you record your current settings now so you can easily re-establish your settings when the update is complete.
3. Press the **MENU** button, and then select [Support](#) > [Software Update](#) > [Update now](#). The Update now pop-up appears.
4. The TV searches on line for the latest software version for your TV.
5. If it does not find an update, the "No new updates" pop-up appears. Press the **EXIT** button to exit.
6. If the TV finds a new version, the Update Request pop-up appears.
7. Select **OK**. The TV updates the software, turns off, and then turns on automatically.



Do not turn off the TV during the Software Update. It may cause the TV to malfunction.

Manually, Using a USB Flash Drive

To update your TV using the Manual method, follow these steps:

1. All video and audio settings return to their default settings after a software update. We recommend you record your current settings so you can easily re-establish these settings when the update is complete.
2. On a computer, visit www.samsung.com.
3. Select GET SUPPORT > Get Downloads.
4. Enter the product's model number into the search field. As you enter the model number, a drop down will display products that match the model number.
5. Click your product's model number in the drop down list.
6. On the page that appears, scroll down to and then click Downloads.
7. Click Firmware in the center of the page.
8. Click the ZIP button in the File column.
9. Click Send in the first pop-up that appears.
10. Click Save in the second pop-up to download, and then save the firmware file to your computer.
11. Unzip the zip archive to your computer. You should have a single folder with the same name as the zip file.
12. Copy the folder to a USB flash drive.
13. Insert the USB flash drive into a USB port of the TV.
14. In the TV's menu, go to Support > Software Update > Update now. The TV searches for the software on the USB drive. When it finds the software, the Update Request pop-up appears.
15. Select OK. The TV updates the software, turns off, and then turns back on automatically.



Do not turn off the TV during the Software Update. It may cause the TV to malfunction.

Enabling Automatic Software Updates

[MENU](#) > [Support](#) > [Software Update](#) > [Auto Update](#) [Try Now](#)

If the TV is connected to the Internet, it can be updated via [Auto Update](#) while watching the TV. When the Background upgrade completed, the update will be applied the next time the TV is used.

 This option requires an Internet connection.

If you agree to the Smart Hub terms and conditions, Auto Update will be set to On automatically. If you don't want the TV's software updated automatically, set [Auto Update](#) ([Support](#) > [Software Update](#) > [Auto Update](#)) to **Off**.

Protecting the TV from Hacking and malicious code

[MENU](#) > [System](#) > [Smart Security](#)

When the TV is connected to the Internet, it is vulnerable to hacks and malicious code. [Smart Security](#) protects the TV and storage media connected to the TV from such threats.

Navigate to [System](#) > [Smart Security](#) and set [Smart Security](#) to **On**.

Checking the TV and Connected Storage Media

[MENU](#) > [System](#) > [Smart Security](#) > [Scan](#)

Navigate to [System](#) > [Smart Security](#) and select [Scan](#). This scans the TV and connected media for the presence of malicious code. If no malicious code is detected, a notification window appears on the screen.

If malicious code is detected...

If malicious code is found, the results of the scan will appear on the screen. This result window displays all malicious code found, and provides options to either quarantine the code or allow it to function.

1. Select all the malicious code you want to quarantine or allow.
2. Select **Block** or **Allow**. This moves the selected malicious code to the **Isolated List** or **Allowed List**.



The **Isolated List** displays all quarantined and blocked malicious code. You can also relocate codes from this list to the Allowed List.



The **Allowed List** displays all allowed malicious code. You can also relocate codes from this list to the Isolated List.

Automatically Scanning when the TV is Powered On

MENU > **System** > **Smart Security** > **Settings** > **Auto Scan**

Navigate to **System** > **Smart Security** > **Settings** and then set **Auto Scan** to **On**. This automatically scans the TV and connected storage media when the TV is powered on.

Automatically Adding malicious code to the Blocked List

MENU > **System** > **Smart Security** > **Settings** > **Move to Isolated List automatically**

Navigate to **System** > **Smart Security** > **Settings** and set **Move to Isolated List automatically** to **On**. Malicious code found during the scanning process is automatically added to the Blocked List.

Using Other Functions

Setting Up a Password

[MENU](#) > [System](#) > [Change PIN](#) [Try Now](#)

Set a PIN (Personal Identification Number) to lock channels, reset the TV, and change the TV settings.

1. Select [System](#) > [Change PIN](#). The PIN input window appears.
2. Enter a PIN. The default PIN is 0000.
3. Enter a new PIN and then enter it again to confirm it. The PIN change is complete.

 If you forget your PIN, you can reset it using your remote control. With the TV turned on, press the following buttons on the remote to reset the PIN to 0000: [MUTE](#) → [+](#) → [RETURN](#) → [-](#) → [RETURN](#) → [+](#) → [RETURN](#). "+" is the Volume Up button, "-" is the Volume Down button.

Changing the Menu Language

[MENU](#) > [System](#) > [Menu Language](#) [Try Now](#)

Use this option to change the menu language. Select [System](#) > [Menu Language](#), and then choose a language from the list.

Checking Notifications

[MENU](#) > [System](#) > [Notifications](#) [Try Now](#)

Select [Notifications](#) from the [System](#) menu to view the list of event messages generated by the TV. [Notifications](#) appear on the screen when events such as an update release for an app or Samsung Account login/logout occurs.

 Select [Delete All](#) to delete all notifications.

 Select [Service Notice](#) to check the SMART TV service notifications in a web browser.





Enabling Voice Guides for the Visually Impaired

MENU > System > Accessibility > Voice Guide

This function is only available in the U.S.A. and Canada.

Voice guides for the menu options are available to aid the visually impaired. Enabling this option provides voice guides for focus movement, channel change, volume change, and various other TV functions.

Navigate to **System > Accessibility > Voice Guide** and set **Voice Guide** to **On**.

-  Press and hold the  button on the Samsung Smart Control to turn on or off **Voice Guide**. Availability depends on the specific area.
-  The Voice Guide is provided in the language that is specified on the **Menu Language** screen. (**System > Menu Language**). However, some languages are not supported by Voice Guide even though they are listed in the **Menu Language** screen.
-  To change the gender of the **Voice Guide**'s voice, navigate to **System > Voice Control > TV Voice**, and then change the **Voice Gender** option.
-  If **Voice Guide** is set to **On**, motion sensor of Samsung Smart Control does not work. To use the motion sensitivity sensor, set **Voice Guide** to **Off**.

The Voice Guide will give information for the following functions on the TV.

-  Voice Guide is not available for some sub-function or function menus. When you access one of those sub-function or function menus, the TV will tell you that Voice Guide is not available.
 - Changing Channels
 - Changing TV Volume
 - Program Info Window (**INFO**)
 - **Channel List**
 - **Source**
 - **Guide**
 - **On TV**
 - **Voice Control**
 - TV Menus

Changing the Volume, Speed, Pitch and Level of Voice Guide

Select **System** > **Accessibility** > **Voice Guide**. Using the following functions, you can configure the **Voice Guide** feature's volume, speed, pitch and level settings.

- **Volume**

Change the **Voice Guide**'s volume level. The volume of the **Voice Guide** is determined by this **Volume** setting. You cannot control the Voice Guard's volume with the TV's volume control.

The **Voice Guide** volume may vary occasionally, depending on the TV volume setting.

- **Speed**

Change the **Voice Guide**'s tempo.

- **Pitch**

Tune the pitch of the Voice Guide.

- **Description Level**

You can adjust the Voice Guide's expertise level to better suit the user's proficiency.

Adjusting the Menu Transparency

MENU > **System** > **Accessibility** > **Menu Transparency** [Try Now](#)

Navigate to **System** > **Accessibility** and adjust the opacity level and the menu's transparency.

 When the **High Contrast** (**System** > **Accessibility** > **High Contrast**) setting is set to **On**, the menu display is automatically set to opaque and you cannot change the **Menu Transparency** settings.

White Text on Black Background (High Contrast)

MENU > **System** > **Accessibility** > **High Contrast**

Navigate to **System** > **Accessibility** and set **High Contrast** to **On**. This option changes major service screens to white text on a black background or changes the transparent TV menus to opaque so that text can be read more easily.

 Press and hold the  button on the Samsung Smart Control to turn **High Contrast** on or off.

Expanding the Smart Hub's Focus Area

[MENU](#) > [System](#) > [Accessibility](#) > [Enlarge](#) [Try Now](#)

Navigate to [System](#) > [Accessibility](#) and set [Enlarge](#) to [On](#). This zooms in the focused item when you use Smart Hub and makes the item larger.

Enabling/Disabling Sound Feedback

[MENU](#) > [System](#) > [General](#) > [Sound Feedback](#) [Try Now](#)

Sound Feedback provides audio cues as you navigate through menus and select menu options. [Sound Feedback](#) is on by default. You can set it to [Low](#), [Medium](#), [High](#), or [Off](#).

Locking/Unlocking the Panel Keys

[MENU](#) > [System](#) > [General](#) > [Panel Lock](#) [Try Now](#)

Use to lock and unlock the TV's front panel buttons (menu, channel, and volume) and the control stick on the back of the TV. Select [System](#) > [General](#) > [Panel Lock](#) and lock/unlock the keys.

Showing/Hiding the Samsung Logo while Booting

[MENU](#) > [System](#) > [General](#) > [Boot Logo](#) [Try Now](#)

Use to enable or disable the Samsung logo display that appears when the TV starts up.

Enabling the TV to Boot Faster



[MENU](#) > [System](#) > [General](#) > [Samsung Instant On](#)

Set Fast Boot on to have the TV boot up faster.

Enabling/Disabling the Front Indicators

[MENU](#) > [System](#) > [General](#) > [Light Effect](#) [Try Now](#)





Use to turn the indicators on the front of the TV on/off. Turning the Light Effect off reduces the TV's power consumption.

-  The color of the TV's light may vary depending on the model.
-  Availability depends on the model.

Enabling Game Mode

[MENU](#) > [System](#) > [General](#) > [Game Mode](#) [Try Now](#)

Game Mode optimizes the TV's settings for playing video games on a gaming console such as PlayStation™ or Xbox™.

-  Game Mode cannot be used for normal TV viewing.
-  Connect the gaming console before enabling Game Mode. Otherwise, the picture quality may suffer.
-  The screen may shake a little.
-  Enabling Game Mode automatically sets the **Picture Mode** to **Standard** and the **Sound Mode** to **Movie**.
-  To use a different external device, first disconnect the game console and disable Game Mode.

Enjoying Rich Colors and Superior Picture Quality (BD Wise)

[MENU](#) > [System](#) > [General](#) > [BD Wise](#) [Try Now](#)



Connecting a Samsung DVD player, Blu-ray player, or home theater system that supports BD Wise enables the richest colors and best possible picture quality. Enabling BD Wise automatically optimizes the TV's resolution.

-  This feature is only available when the external device is connected via an HDMI cable.

Registering the TV as a DivX-Certified Device (Watching For Pay DivX Movies)

MENU > **System** > **DivX® Video On Demand** **Try Now**

To watch DivX DRM protected movies on the TV, you must register the TV as a DivX certified device.

-  DRM stands for Digital Rights Management and is a technical security mechanism to protect the copyright of the content provider.
 -  You can watch movies that you have recorded or free DivX movies without registration.
 -  Visit the DivX website (<http://www.divx.com>) and log into your user account before registering the TV as a DivX-certified device. If you do not have an account, please create one.
1. Select **System** > **DivX® Video On Demand**. A window with a registration code appears on the screen.
 2. Visit the DivX website on a computer, and then click [Register Your Device] under [Support] in the top menu.
 3. Enter the registration code shown on the TV's screen in the [Enter your registration code] field.
 4. Enter the TV's name in the [Name your device] field, and then click [NEXT].
 5. Click [DOWNLOAD], and then save the [device_name.divx] file.
 6. Transfer the [device_name.divx] file from the computer onto a USB device, and then plug the USB device into the TV.
 7. Run the [device_name.divx] file on the TV to register the TV as a DivX-certified device.

Restoring the TV to the Factory Settings

[MENU](#) > [Support](#) > [Self Diagnosis](#) > [Reset](#) [Try Now](#)

This option restores all TV settings (excluding the Internet and network settings) to the factory defaults.

1. Select [Support](#) > [Self Diagnosis](#) > [Reset](#). The Security PIN entry window appears on the screen.
2. Enter the Security PIN, and then select [Yes](#). All settings are then reset. The TV turns off and on again automatically, and then displays the [Setup](#) screen.

 For more information on Setup, refer to the user manual that came with the TV.

Using the TV as a Display Model (exclusively for retail stores)

[MENU](#) > [Support](#) > [Use Mode](#) [Try Now](#)

Select [Support](#) > [Use Mode](#) > [Store Demo](#). This turns the TV into a display model for use in a retail environment.

 For all other uses, select [Home Use](#).

 [Store Demo](#) should be used in retail environments only. With [Store Demo](#), certain functions are disabled and the TV automatically resets itself after a certain amount of time.

Getting Support

The TV has several built-in systems designed for user and TV system support.

Support through Remote Management

[MENU](#) > [Support](#) > [Remote Management](#) [Try Now](#)

If you need assistance with your TV, you can use this feature to let Samsung Electronics diagnose your TV remotely. You will need to read and agree to the service agreement before using this feature. A Samsung Electronics technician will then diagnose, repair, and update your TV remotely. These features are only available when your TV is connected to the Internet.

Getting Remote Support

Samsung Remote Support service offers you one-on-one support with a Samsung Technician who can remotely.

- **Diagnose** your TV
- **Adjust the TV settings** for you
- Reset your TV to its factory settings.
- Install recommended **firmware updates**

How Does it Work?

Having a Samsung Tech service your TV remotely is easy.



Call the Samsung Contact Center and ask for remote support.



Open the menu on your TV and go to the Support section.



Select Remote Management, and then read and agree to the service agreements. When the PIN screen appears, provide the PIN number to the agent.



The agent accesses your TV.

Finding the Information You Need for Service

[MENU](#) > [Support](#) > [Contact Samsung](#) [Try Now](#)

Use this option to display the address of the Samsung website, the call center phone number, your TV's model number, your TV's software version, the Smart Hub info, and other information you may need to get service support from a Samsung call agent or the Samsung website.

There is a problem with the picture

Testing the Picture

[MENU](#) > [Support](#) > [Self Diagnosis](#) > [Picture Test](#) [Try Now](#)

Before you review the list of problems and solutions below, use Picture Test to determine if the problem is caused by the TV. The Picture Test displays a high definition picture you can examine for flaws or faults. If the test picture does not appear or there is noise or distortion, the TV may have a problem. Contact Samsung's Call Center for assistance. If the test picture is displayed properly, there may be a problem with an external device. Please check the connections. If the problem persists, check the signal strength or refer to the external device's user manual.

The Problem	Try this!
Flickering and Dimming	If your Samsung Television is flickering or dimming sporadically, you may need to disable some of the energy efficiency features. Disable Energy Saving (System > Eco Solution > Energy Saving) or Eco Sensor (System > Eco Solution > Eco Sensor) .
Component Connections/Screen Color	If the color on your Samsung television screen is not correct or the black and white colors are off, run Picture Test (Support > Self Diagnosis > Picture Test) . If the test results indicate that the problem is not caused by the TV, do the following: <ul style="list-style-type: none">• Confirm that the TV's video input connectors are connected to the correct external device video output connectors.• Check the other connections as well. If the TV is connected to an external device via a component cable, confirm that the Pb, Pr, and Y jacks are plugged into their proper connectors.
Screen Brightness	If the colors on your Samsung TV are correct but just a little too dark or bright, try adjusting the following settings first. <ul style="list-style-type: none">• Go to the Picture menu and adjust the Backlight/Cell Light (available on different models) Contrast, Brightness, Sharpness, Color, and Tint (G/R) settings.
Ghosting, Blurring, or Juddering	If you notice ghosting or blurring on the screen, use the Auto Motion Plus option (Picture > Picture Options > Auto Motion Plus) to resolve the issue.
Unwanted Powering Off	If your Samsung TV appears to turn off by itself, try disabling some of the TV's energy efficiency features. See if Sleep Timer (System > Time > Sleep Timer) has been enabled. The Sleep Timer automatically turns the TV off after a specified period of time. If the Sleep Timer has not been enabled, see if No Signal Power Off (System > Eco Solution > No Signal Power Off) or Auto Power Off (System > Eco Solution > Auto Power Off) has been enabled and disable them.

The Problem	Try this!
Problems Powering On	<p>When the TV is turned on, the remote control receiver flashes 5 times before the screen turns on.</p> <p>If you are having problems powering on your Samsung television, there are a number of things to check before calling the service department. Confirm that the TV's power cord is connected correctly at both ends and that the remote control is operating normally. Make sure that the antenna cable or cable TV cable is firmly connected. If you have a cable/satellite box confirm that it is plugged in and turned on.</p>
Unable to find a Channel	<p>If your TV is not connected to a cable box or satellite box, run Setup (System > Setup) or Auto Program (Broadcasting > Auto Program).</p>
The TV image does not look as good as it did in the store.	<p>Store displays are all tuned to digital, HD (high definition) channels. If you have an analog cable/set top box, upgrade to a digital set top box. Use HDMI or Component cables to deliver HD (high definition) picture quality. Many HD channels are upscaled from SD (Standard Definition) content. Look for a channel that is broadcasting true HD content.</p> <ul style="list-style-type: none"> • Cable/Satellite Subscribers: Try HD channels from the channel lineup. • Air/Cable Antenna Connection: Try HD channels after running the Auto Program function. <p>Adjust the cable/satellite box's video output resolution to 1080i or 720p.</p>
The picture is distorted.	<p>The compression of video content may cause picture distortions, especially in fast moving pictures from sports programs and action movies.</p> <p>A weak or bad quality signal can cause picture distortions. This is not an issue with the TV.</p> <p>Mobile phones used close to the TV (within 3.2 ft) may cause noise in analog and digital channels.</p>
The color is wrong or missing.	<p>If you're using a Component connection, make sure that the Component cables are connected to the correct jacks. Incorrect or loose connections may cause color problems or a blank screen.</p>
The color is poor or the picture is not bright enough.	<p>Go to the Picture menu and then adjust the Picture Mode, Brightness, Sharpness, and Color settings.</p> <p>See if Energy Saving (System > Eco Solution > Energy Saving) has been enabled. Try resetting the picture. (Picture > Picture Reset)</p>
There is a dotted line on the edge of the screen.	<p>If the Picture Size has been set to Screen Fit, change the setting to 16:9.</p> <p>Change the cable/satellite box resolution.</p>
The picture is black and white.	<p>If you are using AV composite input, connect the video cable (yellow) to the TV's green component jack.</p>

I can't hear the sound clearly

Testing the Sound

[MENU](#) > [Support](#) > [Self Diagnosis](#) > [Sound Test](#) [Try Now](#)

Before you review the list of problems and solutions below, make sure that the **TV Sound Output** menu item is set to **TV Speaker**, and then listen to the speakers again. If the TV still does not play audio, run the **Sound Test**. The **Sound Test** uses a built-in melody to check for sound problems. If the TV does not play sound during the Sound Test, or the sound is distorted, there may be a problem with the TV. Contact Samsung's Call Center for assistance. If the TV plays the Sound Test melody without distortion, there may be a problem with an external device. Please check the connections. If the problem persists, refer to the external device's user manual.

The Problem	Try this!
There is no sound or the sound is too low at maximum volume.	Check the volume control of the device (cable/satellite box, DVD, Blu-ray, etc.) connected to your TV.
The picture is good but there is no sound.	Set Sound > Speaker Settings > TV Sound Output to TV Speaker . If you are using an external device, check the device's audio output option. (For example, you may need to change your cable box's audio option to HDMI if the box connected to your TV is using an HDMI cable.) To listen to the computer sound, connect the external speaker to the computer's audio output connector. If your TV has a headphone jack, make sure there is nothing plugged into it. Reboot the connected device by disconnecting and then reconnecting the device's power cable.
The speakers are making an odd sound.	Make sure that the audio cable is connected to the correct audio output connector on the external device. For antenna or cable connections, check the signal information. A low signal level may cause sound distortions. Run Sound Test (Support > Self Diagnosis > Sound Test).

I can't see 3D images clearly.

Testing 3D Picture Quality

[MENU](#) > [Support](#) > [Self Diagnosis](#) > [3D Picture Test](#)

 To test 3D picture quality, you must be wearing 3D glasses and the glasses and the TV must be paired.

Before you review the list of problems and solutions below, use 3D Picture Test to determine if the problem is caused by the TV. The 3D Picture Test displays a high definition picture you can examine for flaws or faults. If the test picture does not appear or there is noise or distortion, the TV may have a problem. Contact Samsung's Call Center for assistance. If the test picture is displayed properly, there may be a problem with an external device. Please check the connections. If the problem persists, check the signal strength or refer to the external device's user manual.

The Problem	Try this!
The 3D glasses are not working correctly.	Make sure the glasses are powered on. The 3D feature may not work properly if there is another 3D product or an electronic device running nearby. If there is a problem, keep other electronic devices as far away as possible from the 3D Active Glasses.
I can't see 3D images clearly.	The ideal viewing distance is three times or more the height of the screen. We also recommend watching 3D content with your eyes level with the screen.
The batteries in the 3D glasses are flat.	Turn off the 3D glasses when they are not in use. If you leave the 3D glasses on, the battery lifespan is shortened.

There is a problem with the broadcast.

The Problem	Try this!
The TV is not receiving all channels.	If your TV is not connected to a cable box or satellite box: <ul style="list-style-type: none">• Confirm that the coaxial cable is securely connected to the TV.• If you are using an antenna, verify it is positioned correctly and the all the connections are secure.• Run Setup (System > Setup) or Auto Program (Broadcasting > Auto Program).
There are no captions with digital channels.	Go to Caption (System > Accessibility > Caption) and change the Caption Mode . Some channels may not have caption data.
The picture is distorted.	The compression of the video content may cause picture distortions. This is especially true with fast moving pictures from sports programs and action movies. A weak signal can cause picture distortions. This is not a problem with the TV.

My computer won't connect.

The Problem	Try this!
The "Mode Not Supported" message appears.	Set your PC's output resolution so it matches a resolution supported by the TV.
The video is OK but there is no audio.	If you are using an HDMI connection, check the audio output setting on your PC. If you are using a DVI to HDMI cable, a separate audio cable is required.

I can't connect to the Internet.



The Problem	Try this!
The wireless network connection failed.	Confirm your wireless modem/router is on and connected to the Internet. Reset your wireless modem/router by turning it off, waiting for 15 seconds, and then turning it on again. Run Network Setup (MENU > Network > Network Settings).
The software update over the Internet has failed.	Check the network connection status (MENU > Network > Network Status). If the TV is not connected to a network, connect to a network. The upgrade stops if you already have the latest software version.

The Schedule Recording/Timeshift function isn't working.

This function is not available in the U.S.A. and Canada.

There is something wrong with the TV.	Try this!
The TV cannot recognize the USB device or the Format Device , Check Device , or Device Performance Test has failed.	Refer to the USB device's manual and see if data can be stored on it. Check if the USB device is in a locked state. Check if the USB device was formatted when it was connected to a computer. Formatting a USB device after connecting it to the TV may result in a formatting failure. If Device Performance Test or Format Device has failed, there may be a problem with the USB device or its specifications. Try using a different USB device.
There is a message saying I need to format the USB storage device.	Check if the USB device is in a locked state. Use the USB recovery function to recover the USB device.
Schedule Recording cannot be used.	Check if there is a USB device connected to the TV. Check if the channel is a digital channel that can be recorded. Recording will automatically stop if the signal becomes too weak. The Timeshift function will not work if there isn't enough storage space on the USB device.
I get a performance test failure message and then Schedule Recording and the Timeshift operation stops working.	This problem can occur when using a low-performance USB storage device that does not support recording. A USB hard drive with a speed of 5,400rpm or above is recommended. A USB memory Stick is not supported.

Anynet+ (HDMI-CEC) isn't working.

The Problem	Try this!
Anynet+ does not work.	<p>Confirm that the device is an Anynet+ device. The Anynet+ system supports Anynet+ devices only.</p> <p>Check if the power cord of the Anynet+ device is properly connected.</p> <p>Check the cable connections of the Anynet+ device.</p> <p>Go to System and see if Anynet+ (HDMI-CEC) has been set to On.</p> <p>Check whether the TV remote control is in TV mode.</p> <p>Check whether the remote control is Anynet+ compatible.</p> <p>Anynet+ may not function when some other functions are active, including Channel Search, Smart Hub, Start Up, etc.</p> <p>If you have disconnected and then reconnected the HDMI cable, scan for devices again or turn your TV off and on.</p>
I want to start Anynet+.	<p>Check if the Anynet+ device is properly connected to the TV, and then navigate to the System menu to see if Anynet+ (HDMI-CEC) is set to On.</p> <p>Once you have verified that Anynet+ is on:</p> <ul style="list-style-type: none">  On the Samsung Smart Control, press the KEYPAD button, and then select the TOOLS button on the On-Screen Remote. A list appears. Select Anynet+ (HDMI-CEC) from the list, and then a device.  On a standard remote, press the TOOLS button. A list appears. Select Anynet+ (HDMI-CEC) from the list, and then a device.
I want to exit Anynet+.	<p>Select View TV from the Anynet+ menu.</p> <p>Select a non-Anynet+ device from the Source list.</p>
The message "Connecting to Anynet+ device..." or "Disconnecting from Anynet+ device" appears on the screen.	<p>You cannot use the remote control when you are configuring Anynet+ or switching to a viewing mode. Use the remote control after the TV has completed the Anynet+ configuration or has switched to a viewing mode.</p>
The Anynet+ device won't play.	<p>You cannot use the play function when Setup is in progress.</p>
The connected device is not displayed.	<p>Check whether the device supports Anynet+.</p> <p>Check whether the HDMI cable is properly connected.</p> <p>Go to System and see if Anynet+ (HDMI-CEC) has been set to On.</p> <p>Scan for Anynet+ devices again.</p> <p>Anynet+ devices must be connected to the TV using an HDMI cable. Make sure the device is connected to your TV with an HDMI cable. Some HDMI cables may not support Anynet+.</p> <p>If the connection is terminated because there has been a power failure or the HDMI cable has been disconnected, please scan for the device again.</p>
The TV audio is not being played through the receiver.	<p>Connect an optical cable to the TV and the receiver.</p> <p>ARC enables the TV to output digital sound via the HDMI (ARC) port.</p> <p>However, ARC is only available when the TV is connected to an audio receiver that supports ARC.</p>

I am having trouble launching/using apps.

The Problem	Try this!
I launched an app, but it's in English. How can I change the language?	Languages supported by the app may be different from the user interface language. The ability to change the language depends on the service provider.
My application is not working.	Check with the service provider. Refer to the help section on the application service provider's website.

My file won't play.

The Problem	Try this!
Some files can't be played.	This problem may occur with high-bitrate files. Most files can be played back, but you might experience problems with high-bitrate files.

I want to reset the TV.

Reset	Path	Description
Reset Settings	MENU > Support > Self Diagnosis > Reset	Reset Picture , Sound , Channel , Smart Hub , and all other settings, except for the network settings, default settings.
Resetting Smart Hub	MENU > Smart Hub > Smart Hub Reset	Resets all Smart Hub settings to their factory defaults and deletes all information related to Samsung accounts, linked service accounts, Smart Hub service agreements, and Smart Hub applications.

Other Issues

The Problem	Try this!
The TV is hot.	Watching TV for an extended period of time causes the panel to generate heat. The heat from the panel is dissipated through internal vents running along the top of the TV. The bottom, however, may feel hot to the touch after extended use. Children watching TV need constant adult supervision to prevent them from touching the TV. This heat, however, is not a defect and does not affect the TV's functionality.
The picture won't display in full screen.	HD channels will have black bars on either side of the screen when displaying upscaled SD (4:3) content. Black bars will appear at the top and bottom of the screen when you watch movies that have aspect ratios different from your TV. Adjust the picture size options on your external device or set the TV to full screen.
The "Mode Not Supported" message appears.	The output resolution of the attached device is not supported by the TV. Check the TV's supported resolutions and adjust the external device's output resolution accordingly.
The Captions item in the TV menu is grayed out.	You cannot select the Caption menu if you have selected a source connected to the TV via HDMI or Component. To view captions, turn on the external device's caption function.
The TV smells of plastic.	This smell is normal and will dissipate over time.
The Signal Information option under Self Diagnosis isn't activated.	Verify that the current channel is a digital channel. The Signal Information is only available for digital channels.
The TV is tilted to the side.	Remove the base stand from the TV and reassemble it.

The Problem	Try this!
The Broadcasting option has been deactivated.	Broadcasting is only available when the Source is set to TV . The Broadcasting menu cannot be accessed while you watch TV using a cable box or satellite receiver.
The settings are lost after 5 minutes or every time the TV is turned off.	If the Use Mode is set to Store Demo , the TV's audio and video settings are automatically reset every 5 minutes. Change the Use Mode (Support > Use Mode) to Home Use .
There is an intermittent loss of audio or video.	Check the cable connections and reconnect them. Loss of audio or video can be caused by using overly rigid or thick cables. Make sure the cables are flexible enough for long term use. If you are mounting the TV to a wall, we recommend using cables with 90-degree connectors.
There are small particles on the TV's bezel.	This is part of the product's design and is not a defect.
The PIP menu is not available.	PIP functionality is only available when you are viewing video from an HDMI or Component source on the main screen.
A POP (TV's internal banner ad) appears on the screen.	Change the Use Mode (Support > Use Mode) to Home Use .
The TV is making a popping noise.	The expansion and contraction of the TV's outer casing may cause a popping noise. This does not indicate a product malfunction. The TV is safe to use.
The TV is making a humming noise.	Your TV utilizes high-speed switching circuits and high levels of electrical current. Depending on the TV's brightness level, the TV may seem slightly noisier than a conventional TV. Your TV has undergone strict quality control procedures that meet our demanding performance and reliability requirements. Some noise coming from the TV is considered normal and is not an acceptable cause for an exchange or refund.

Before Using the Recording and Timeshift Functions

 Availability depends on the specific model and area.

Before Using the Recording and Schedule Recording Functions

 Recording is not supported in the U.S.A and Canada.

- To set up a Schedule Recording, you must first set the TV's clock. Set the **Clock (System > Time > Clock)**.
- Recordings are DRM-protected and therefore cannot be played back on a computer or on a different TV. In addition, these files cannot be played back on your TV if its video circuit has been replaced.
- A USB hard drive with a speed of 5,400rpm or above is recommended. However, RAID-type USB hard drives are not supported.
- USB memory sticks are not supported.
- The total recording capacity may vary depending on the amount of available hard drive space and the recording quality level.
- **Schedule Recording** requires at least 100MB of free space on the USB storage device. Recording will stop if the available storage space falls below 50MB while recording is in progress.
- If the available storage space falls below 500MB while both the Schedule Recording and Timeshift functions are in progress, only the recording will stop.
- The maximum recording time is 360 minutes.
- A video is played according to the TV settings.
- If the input signal is changed while recording is in progress, the screen will go blank until the change is made. In this case, recording will resume, but **●** will not be available.
- **Device Performance Test** must be performed on the USB storage device connected to the TV before a recording can be made. To perform the **Device Performance Test**, select **Recorded TV** in the **On TV** panel or **USB Drive** in the **MULTIMEDIA** panel and then select the recording device. When you make a recording on the **Guide** or Programme Info screen, if the USB storage device has failed in the **Device Performance Test**, the **Format Device** and **Device Performance Test** are performed again.
- When using the Record or Schedule Recording function, the actual recording may start a second or two later than the specified time.
- If the Schedule Recording function is operating while a recording is being made on an HDMI-CEC external device, the priority is given to the Schedule Recording.
- Connecting a recording device to the TV automatically deletes abnormally saved recording files.
- If the **Off Timer** or **Auto Power Off** has been set, the TV will override these settings, continue to record, and turn off after the recording has ended.

Before the Using Timeshift Function





 Timeshift is not supported in the U.S.A and Canada.

- A USB hard drive with a speed of 5,400rpm or above is recommended. However, RAID-type USB hard drives are not supported.
- USB memory sticks or flash drives are not supported.
- The total recording capacity may vary depending on the amount of available hard drive space and the recording quality level.
- If the available storage space falls below 500MB while both the Schedule Recording and Timeshift functions are in progress, only the recording will stop.
- The maximum amount of time available for the Timeshift function is 90 minutes.
- The Timeshift function is not available for locked channels.
- A time-shifted video is played according to the TV settings.
- Before the Timeshift function can be used, the **Device Performance Test** must be performed on the USB storage device connected to the TV. To perform the **Device Performance Test**, select **Recorded TV** in the **On TV** panel or **USB Drive** in the **MULTIMEDIA** panel and then select the recording device.
- The Timeshift function may be terminated automatically once it reaches its maximum capacity.
- The Timeshift function requires at least 1.5GB of free space available on the USB storage device.
- Launching an app, switching to an analogue channel, or changing the TV to a mode that does not support the Timeshift function automatically terminates the Timeshift function. The Timeshift operation will resume if the TV is changed back to a digital channel again.

Read Before Using 3D Viewing Mode

3D Precautions

Warning

- When viewing a 3D video under a fluorescent lamp (50 Hz - 60 Hz) or 3-wavelength lamp, you may notice a small amount of screen flickering.
 -  If this occurs, dim or turn off the light.
- Switching the input mode while watching a 3D movie may disable the 3D function on the TV.
 -  As a result, the 3D glasses may not function and the movie may not be displayed properly.
- Ensure you are within the working distance of the glasses when you view a 3D video.
 -  The images may not be viewable in 3D if you move outside of the working distance for 3 seconds.
 -  If the 3D glasses are moved outside of their working distance, the signal from the TV will disconnect and the glasses' 3D function will turn off after several seconds. When this happens, the red LED will turn on for 3 seconds.
- If you lie on your side while watching TV with 3D active glasses, the picture may appear dark or may not be visible. The actual 3D effect may be experienced differently depending on the viewer. The 3D effect may not be visible if the visual ability of your left eye differs greatly from the visual ability of your right eye.
- If a part of the 3D glasses or lenses is defective or damaged, it cannot be repaired and the glasses should be replaced. If the glasses stop working within the warranty period, the glasses can be repaired or replaced for free. If the glasses have been damaged due to the fault of the customer or the warranty period has expired, a new pair of glasses will have to be purchased.
- The 3D glasses may not work properly due to interference from other 3D products or electronic devices that operate on the 2.4GHz frequency such as a microwave oven or Internet AP. If the 3D function malfunctions due to interference, please move all other electronic or wireless communication devices as far away from the glasses and the TV as possible.
- The vividness of the image may appear degraded if you view 3D video in a place that is exposed to direct sunlight or illumination.
- The 3D glasses may malfunction if there is an electric field or metallic object such as a steel plate nearby. Keep the glasses as far away as possible from electric fields and metallic objects.
- With SSG-3570 model glasses, the glasses may power off if you remain stationary while viewing 3D video for an extended period of time.
- With SSG-3570 model glasses, if the 3D glasses do not function immediately after you put them on when the TV is in 3D mode, take them off and then put them back on.

⚠ Caution

IMPORTANT HEALTH AND SAFETY INFORMATION FOR 3D IMAGES. READ THE FOLLOWING CAUTIONS BEFORE YOU OR YOUR CHILD USE THE 3D FUNCTION.

- Adults should frequently check on children who are using the 3D function. If there are any complaints of tired eyes, headaches, dizziness, or nausea, stop the child from viewing the 3D TV and ensure that they rest.
- Do not use the 3D glasses for other purposes such as general wear, sunglasses, protective goggles, etc.
- Some viewers may experience discomfort such as dizziness, nausea, and headaches while viewing 3D TV. If you experience any of these symptoms, stop viewing the 3D TV, remove the 3D glasses, and rest for awhile.
- Watching 3D pictures for an extended period of time may cause eye strain. If you experience any eye strain, stop viewing the 3D TV, remove the 3D glasses, and rest for awhile.
- Do not use the 3D function or 3D glasses while walking or moving around. Using the 3D function or 3D Active Glasses while moving around may result in injury from running into objects, tripping, and/or falling.
- Do not sleep with the 3D glasses on. You can damage or break the temples.
- The temples on your 3D glasses are not foldable. Forcing the temples to fold will damage the 3D glasses.
- With SSG-3570 model glasses, do not shake your 3D glasses repeatedly. Shaking the glasses will power them on and can cause the battery to discharge faster than it would normally.
- With SSG-5100GB and SSG-5150GB models glasses, there is a danger of explosion if the battery is incorrectly replaced.
- With SSG-5100GB and SSG-5150GB models glasses, make sure to replace the battery with the same type.

Safety Precautions

The following safety instructions are to ensure your personal safety and prevent property damage. Please read the following to ensure the proper use of the product.

- Do not place the product in a location exposed to direct sunlight, heat, fire, or water. Exposure may result in a product malfunction or fire.
- Do not apply force to the lenses of the 3D glasses. Do not drop or bend the product. Applying force, dropping, or bending may result in a 3D glasses malfunction.
- Keep the components of the 3D glasses out of reach of children. Especially, ensure children do not swallow any of the components. If your child swallows a component, consult your doctor immediately.
- When cleaning the product, do not spray water or cleaner directly onto the surface of the product. Spraying water or cleaner directly onto the glasses may result in fire or electric shock, damage to the product's surface, or cause the indicator labels on the product's surface to come loose.
- Do not apply chemicals containing alcohol, solvent, or surfactant such as wax, benzene, thinner, pesticide, air freshener, lubricant, or cleaner to the product. These chemicals may cause the product's exterior to be discolored or cracked, or labels or instructions to be removed. Use only a soft cloth such as superfine fibers or cotton flannels for cleaning the product as the surface or the lenses easily crack. Because the product can be easily scratched with foreign substances, make sure to dust off the cloth before using.
- Do not disassemble, or attempt to repair or modify your 3D active glasses by yourself.
- Be careful not to let the temple ends of the 3D active glasses harm your eye.
- Do not sleep with the 3D glasses on. You can break the arms.
- Use your hands to put on or remove the 3D glasses.
- For SSG-5100 and SSG-5150 model glasses, use only the specified standard batteries. When replacing the battery, insert the battery so that its polarity (+, -) is correct. Failing to do so may damage the battery or result in fire, personal injury or environmental damage caused by liquid leaking from the battery.
- For SSG-5100 and SSG-5150 model glasses, keep the used battery out of the reach of children so that they do not accidentally swallow it. If your child swallows the battery, consult your doctor immediately.
- Swallowing the cylindrical (button type) battery can cause serious damage to your internal organs. If this happens, contact a doctor immediately.

S-Recommendation Disclaimer

Some of the features recommended by S-Recommendation may not be available, depending on the model.

For U.S.A. only

S Recommendation with Voice Interaction

For recommendations given in response to common speech commands:

Voice Interaction is limited to the official language of the country of purchase. Performance may vary based on content availability, the clarity and volume of your voice, and ambient noise levels. Strong regional accents may not be recognized.

Certain Samsung Smart TV features may not be available if you do not give your expressed consent to the collection and use of personal information.

Certain features within S Recommendation require Internet access and may not be available based on service provider, language, dialect, and region.

On TV listings are available from many major video providers and broadcasters. For a complete list of supported video providers, visit www.samsung.com/OnTV.

Your remote control may differ from the images shown in this manual.

S Recommendation

For content recommendations given to fit your TV viewing preferences:

Certain Samsung Smart TV features may not be available if you do not give your expressed consent to the collection and use of personal information.

Certain features within S Recommendation require Internet access and may not be available based on service provider, language, dialect, and region.

On TV listings are available from many major video providers and broadcasters. For a complete list of supported video providers, visit www.samsung.com/ONTV.

Your remote control may differ from the images shown in this manual.

Supported Resolutions for 3D Modes

These specifications apply to the 16:9 display ratio only.

HDMI

- 3D Mode:  (L/R),  (T/B)

Resolution	Frequency (Hz)
1280 x 720p	50 / 60
1920 x 1080i	50 / 60
1920 x 1080p	24 / 25 / 30 / 50 / 60

- 3D Mode:  (Horizontal Line),  (Vertical Line),  (Pixel),  (Frame)

Resolution	Frequency (Hz)
1280 x 720p	50 / 60
1920 x 1080i	50 / 60
1920 x 1080p	25 / 30

Component

Resolution	Frequency (Hz)
1280 x 720p	59.94 / 60
1920 x 1080i	59.94 / 60
1920 x 1080p	23.98 / 24 / 29.97 / 30 / 59.94 / 60

Digital Channel

Resolution	Frequency (Hz)
1280 x 720p	59.94 / 60
1920 x 1080i	59.94 / 60

Videos/Photos

Refer to the "Read Before Playing Photo, Video, or Music Files" section.

Computer via HDMI Cable.

The optimal resolution for computers connected to the TV via an HDMI cable is 1920 x 1080. If you select another resolution, the TV may not display 3D images correctly and may not be able to display the computer video in full screen.

Read Before Using Voice, Motion, or Face Recognition

Voice, Motion, and Face Recognition Precautions

Face Recognition

- This product saves thumbnail images of users' faces for use during the Face Login.
- Logging into the Smart Hub via Face Recognition may be less secure than logging in using an ID and password.

Using the TV Camera

- Under some circumstances and under certain legal conditions, the use/misuse of the TV camera may result in illegal actions. There may be obligations under local privacy laws regarding the protection of individuals concerning personal data and on the free movement of such data, and possibly other laws including criminal laws regulating camera surveillance both in the workplace and elsewhere.
- By using the TV camera, users agree that it will not be used (i) in locations where cameras are generally prohibited (such as bathrooms, locker rooms or changing rooms), (ii) in any manner that will result in an invasion of a person's privacy, or (iii) in violation of any applicable laws, regulations or statutes.
- When you are no longer using the camera, close the lens cover of the camera. This prevents any inadvertent or unintentional camera operation.

Motion Control

- **Motion Control** is worked by connected to the camera. For **Motion Control** to work, you must be within the camera's recognition range. The camera's recognition range varies depending on the ambient light level and other factors.
- Run the **Motion Control Environment Test** before using Motion Control to determine the camera's recognition range.
- You may experience physical fatigue when using **Motion Control** for extended periods.

Voice Control

- Voice Control is not available in all languages, dialects, or regions. The performance varies depending on the language chosen, voice volume, and ambient noise levels in the surrounding area.
- Voice Text Input requires that you agree to any third-party app's voice privacy policy and that you provide Samsung with your MAC address and other private information.
- Voice Text Input lets you enter text using voice commands instead of a mouse, keyboard, or remote control. This feature is particularly useful for searching, browsing the web, and using applications.
- You must agree to the following privacy notices before using Interactive Voice Control:
 - Voice Recognition Privacy Notice and Nuance Privacy Notice

Requirements for Using Voice, Motion, or Face Recognition

Requirements for Using Voice Recognition

- The voice recognition rate varies depending on the volume/tone, pronunciation, and ambient sound environment (TV sound and ambient noise).

Requirements for Using Motion Recognition

- Before using motion recognition, make sure the TV's camera has been turned on.
- You should be located between 4.9 ft and 11.5 ft from the camera. The actual recognition range may vary depending on the camera angle and other factors.
- Motion Control relies on the TV camera and therefore will not function if the camera is pointed up or down. Adjust the camera's position to toward front. Do not point the camera directly at the sun or any other light source or obstruct its view.
- For the camera to recognize movement, you must stand out from the background.
- The appropriate ambient brightness is 50 to 500 lux. (100 Lux: Bathroom, 400 Lux: Living Room)
- Avoid direct sunlight when using Motion Control.
- Run the [Motion Control Environment Test](#) to assess the camera's recognition range before using Motion Control.

Requirements for using Face Recognition

- You should be located between 4,9 ft and 13,1 ft from the camera. The actual recognition range may vary depending on the camera angle and other factors.
- The appropriate ambient brightness is 50 to 500 lux. (100 Lux: Bathroom, 400 Lux: Living Room)
- Face Recognition can recognize up to 5 different users at a time.
- The TV may have difficulty recognizing twins and people with similar faces as two different individuals.
- Note the following when using Face Recognition:
 - Do not cover your face with a hat, a pair of sunglasses, or your hair.
 - Your entire face must be visible to the camera. Avoid shadows over your face. Shadows prevent the camera from recognizing faces accurately.
 - Keep your expression as neutral as possible. In addition, keep your mouth closed and as neutral as possible.
 - When you log into your Samsung account, your facial expression must be the same as the facial expression you had when you registered.

Read Before Using Apps

- Due to the product characteristics featured on the Samsung Smart Hub, as well as limitations in available content, certain features, applications, and services may not be available on all devices or in all territories. Some Smart Hub features may also require additional peripheral devices or membership fees. Visit <http://www.samsung.com> for more information on specific device information and content availability. Services and content availability are subject to change without prior notice.
- Samsung Electronics takes no legal responsibility whatsoever for any interruption of app services caused by the service provider for any reason.
- Application services may be provided in English only and available content may vary depending on the area.
- For more information about applications, visit the applicable service provider's website.
- An unstable Internet connection may cause delays or interruptions. In addition, applications may terminate automatically depending on the network environment. If this occurs, check your Internet connection and try again.
- Application services and updates may become unavailable.
- Application content is subject to change by the service provider without prior notice.
- Specific services may vary depending on the version of the application installed on the TV.
- An application's functionality may change in future versions of the application. If this occurs, run the application's tutorial or visit the service provider's website.
- Depending on the service provider's policies, certain applications may not support multitasking.

Read Before Using the Web Browser

- Select **Web Browser**. The browsing screen may differ from the one on your computer.
- The web browser is not compatible with Java applications.
- You cannot download files. If you attempt to download a file, you will receive an error message instead.
- The web browser may not be able to access certain websites.
- Playing Flash videos may be restricted.
- E-commerce for online purchases is not supported.
- With websites that have scrollable windows, scrolling a window can result in corrupted characters.
- ActiveX is not supported.
- Certain options are not accessible in Link Browsing mode. (Switch to Pointer Browsing to activate those options.)
- Only a limited number of fonts are supported. Certain symbols and characters may not be displayed properly.
- The response to remote commands and the resulting on-screen display may be delayed while a webpage is loading.
- Loading a webpage may be delayed or suspended completely with certain operating systems.
- The copy and paste operations are not supported.
- When composing an email or a simple message, certain functions such as the font size and color selection may not be available.

- There is a limit to the number of bookmarks and the size of the log file that can be saved.
- The number of windows that can be opened concurrently varies depending on the search conditions and the TV model.
- The web browsing speed will vary depending on the network environment.
- Embedded videos can play with a picture-in-picture (PIP) at the same time.
- The web browser supports .mp3 audio files only.
- The web browser supports a specific file format for importing and exporting bookmarks. (Compatible Format: Netscape-bookmarkfile- 1)
- The folder tree information is not included when importing and exporting bookmarks.
- Exporting bookmarks to a USB device connected to the TV saves the bookmarks under a folder named "Samsung SmartTV Bookmark".
- If the **Clock (System > Time > Clock)** has not been set, the browsing history will not be saved.
- The browsing history is saved from latest to oldest, with the oldest entries being overwritten first.
- Depending on the types of video/audio codecs supported, it might not be possible to play certain video and audio files while playing Flash content.
- Video sources from PC-optimized streaming service providers may not play properly on our proprietary web browser.
- Using the on-screen QWERTY keyboard automatically disables PIP. (Except when entering a URL.)

Read Before Playing Photo, Video, or Music Files

Photo, Video, and Music File Use Limitations

- The TV supports MSC (Mass Storage Class) USB devices only. MSC is a class designation for mass storage devices. Types of MSC devices include external hard drives, flash card readers, and digital cameras. (USB hubs are not supported.) These kinds of devices must be connected directly to the TV's USB port. The TV may not be able to recognize the USB device or read the files on the device if it is connected to the TV via a USB extension cable. Do not disconnect the USB device while transferring files.
- When connecting an external hard drive, use the USB (HDD) port. We recommend that you use an external hard drive with its own power adapter.
- Certain digital cameras and audio devices may not be compatible with the TV.
- If there are multiple USB devices connected to the TV, the TV might not be able to recognize some or all the devices. USB devices that use high-power input should be connect the USB [5V, 1A] port.
- The TV supports the FAT, exFAT, and NTFS file systems.
- After sorting files in the Folder view mode, the TV can display up to 1000 files per folder. If the USB device contains more than 8,000 files and folders, however, some files and folders might not be accessible.
- The PTP (pier to pier) connection mode is available only for digital cameras. If you connect a smartphone or tablet to the TV using PTP mode, the TV will not recognize it.

Compatible Storage Devices for File Transfers

Storage device containing media content	Target device
USB Device	DLNA Device, SugarSync, Dropbox, SkyDrive, Mobile Device
Camera	DLNA Device
DLNA Device	USB Device
SugarSync, Dropbox, SkyDrive	USB Device
Mobile Device	USB Device

Supported External Subtitles

 Certain files, depending on how they were encoded, may not play on the TV.

Name	Format
MPEG-4 Timed text	.ttxt
SAMI	.smi
SubRip	.srt
SubViewer	.sub
Micro DVD	.sub or .txt
SubStation Alpha	.ssa
Advanced SubStation Alpha	.ass
Powerdivx	.psb
SMPTE-TT Text	.xml

Supported Internal Subtitles

 Certain files, depending on how they were encoded, may not play on the TV.

Name	Format
Xsub	AVI
SubStation Alpha	MKV
Advanced SubStation Alpha	MKV
SubRip	MKV
VobSub	MKV
MPEG-4 Timed text	MP4
TTML in smooth streaming	MP4
SMPTE-TT Text	MP4
SMPTE-TT PNG	MP4

Supported Image Formats and Resolutions

 Certain files, depending on how they were encoded, may not play on the TV.

File Extension	Format	Resolution
*.jpg *.jpeg	JPEG	15360x8640
*.png	PNG	4096x4096
*.bmp	BMP	4096x4096
*.mpo	MPO	15360x8640

Supported Music Formats and Codecs

 Certain files, depending on how they were encoded, may not play on the TV.

File Extension	Format	Codec	Note
*.mp3	MPEG	MPEG1 Audio Layer 3	
*.m4a *.mpa *.aac	MPEG4	AAC	
*.flac	FLAC	FLAC	Supports up to 2 channels
*.ogg	OGG	Vorbis	Supports up to 2 channels
*.wma	WMA	WMA	Supports up to 10 Pro 5.1 channels WMA lossless audio is not supported Supports up to the M2 profile
*.wav	wav	wav	
*.mid *.midi	midi	midi	Supports type 0 and type 1 Search is not supported Supports USB device only
*.ape	ape	ape	
*.aif *.aiff	AIFF	AIFF	
*.m4a	ALAC	ALAC	

Supported Video Codecs

 Certain files, depending on how they were encoded, may not play on the TV.

File Format	Container	Video Codecs	Resolution	Frame Rate (fps)	Bitrate (Mbps)	Audio Codec
*.avi *.mkv *.asf *.wmv *.mp4 *.mov *.3gp *.vro *.mpg *.mpeg *.ts *.tp *.trp *.mov *.flv *.vob *.svi *.m2ts *.mts *.divx	AVI MKV ASF MP4 3GP MOV FLV VRO VOB PS TS SVAF	HEVC(H.265)	1920x1080	FHD: MAX 30 HD: MAX 60	8	Dolby Digital LPCM ADPCM(IMA, MS) AAC HE-AAC WMA Dolby Digital Plus MPEG(MP3) DTS(Core, LBR) G.711(A-Law, μ-Law)
		Motion JPEG			30	
		H.264 BP / MP / HP				
		DivX 3.11 / 4 / 5 / 6				
		MPEG4 SP/ASP				
		Window Media Video v9(VC1)				
		MVC				
		MPEG2				
		MPEG1				
		Microsoft MPEG-4 v1, v2, v3				
		H.263 Sorrenson			MAX 30	
		Window Media Video v7(WMV1), v8(WMV2)				
		VP6				
		*.webm			WebM	

Other Restrictions

- Codecs may not function properly if there is a problem with the content.
- Video content does not play or does not play correctly if there is an error in the content or container.
- Sound or video may not work if they have standard bit rates/frame rates above the TV's compatibility ratings.
- If the Index Table is has an error, the Seek (Jump) function will not work.
- When playing video over a network connection, the video may not play smoothly because of data transmission speeds.
- Some USB/digital camera devices may not be compatible with the TV.
- HEVC codec is only available in MKV / MP4 / TS containers. Streaming and DLNA are not supported.

Video Decoders

- Supports up to H.264, Level 4.1 (does not support FMO/ASO/RS)
- VC1 AP L4 is not supported.
- All video codecs excluding WMV v7, v8, MSMPEG4 v3, MVC, and VP6:
Below 1280x720: 60 frame max
Above 1280x720: 30 frame max
- GMC 2 or above is not supported.
- Supports SVAF Top/Bottom, Side by Side, and Left/Right view sequence type (2ES) only.
- Supports BD MVC specs only.

Audio Decoders

- WMA 10 Pro supports up to 5.1 channels. Supports up to the M2 profile.
- WMA lossless audio is not supported.
- QCELP and AMR NB/WB are not supported.
- Vorbis is supported for up to 5.1 channels.
- Dolby Digital Plus is supported for up to 5.1 channels.
- The DTS LBR codec is only available for MKV / MP4 / TS containers.

Read After Installing the TV

Picture Sizes and Input Signals

Input Signal	Picture Size
Analog Channel/External Input	16:9, Zoom1, Zoom2, 4:3
Component (480i, 480p)	16:9, Zoom1, Zoom2, 4:3
Component (720p)	16:9, Wide Fit, 4:3
Component (1080i, 1080p)	16:9, Wide Fit, 4:3, Screen Fit
Digital Channel (720p)	16:9, Wide Fit, 4:3, Smart View 2
Digital Channel (1080i, 1080p)	16:9, Wide Fit, 4:3, Screen Fit, Smart View 2
HDMI (720p, 1080i, 1080p)	16:9, Wide Fit, 4:3, Screen Fit, Smart View 1, Smart View 2

The **Picture Size** setting is applied to the current source. The applied **Picture Size** will remain in effect whenever you select that source unless you change it.

Installing an Anti-Theft Lock

An anti-theft lock is a physical device that can be used to protect the TV against theft. Look for the lock slot on the back of the TV. The slot has a  icon next to it. To use the lock, wrap the lock cable around an object that is too heavy to carry and then thread it through the TV's lock slot. The lock is sold separately.

The method of using an anti-theft lock may differ for each TV model. Refer to the lock's user manual for more information.

 Availability depends on the model.

Read Before Setting Up a Wireless Internet Connection

Wireless Internet Precautions

- This TV supports the IEEE 802.11a/b/g /n communication protocols. Samsung recommends using IEEE 802.11n. Video files stored on a device connected to the TV via DLNA may not play back smoothly.
- To use wireless Internet, the TV must be connected to a wireless router or modem. If the wireless router supports DHCP, the TV can use a DHCP or static IP address to connect to the wireless network.
- Select a channel that is not currently in use for the wireless router. If the channel set for the wireless router is currently being used by another device, the result is usually interference and/or a communications failure.
- Most wireless networks have an optional security system. To enable a wireless network's security system, you need to create a password using characters and numbers. This password is then needed to connect to a security-enabled AP.

Wireless Security Protocols

The TV only supports the following wireless network security protocols.

- Authentication Modes: WEP, WPAPSK, WPA2PSK
- Encryption Types: WEP, TKIP, AES

In compliance with the newest Wi-Fi certification specifications, Samsung TVs do not support WEP or TKIP security encryption in networks running in the 802.11n mode.

If the wireless router supports WPS (Wi-Fi Protected Setup), you can connect the TV to your network using PBC (Push Button Configuration) or a PIN (Personal Identification Number). WPS automatically configures the SSID and WPA key settings.

The TV cannot connect to non-certified wireless routers.

Read Before Connecting a Computer (Supported Resolutions)

When you connect your TV to a computer, set the computer's video card to one of the standard resolutions listed in the tables below or on the next page. The TV will automatically adjust to the resolution you choose. Note that the optimal and recommended resolution is 1920 x1080.

Choosing a resolution not included in the tables can result in a blank screen or just the power indicator turning on.

Refer to the user manual of your graphics card for compatible resolutions.

IBM

Resolution (DotsxLines)	Display Format	Horizontal Frequency (KHz)	Vertical Frequency (Hz)	Clock Frequency (MHz)	Polarity (Horizontal/Vertical)
720x400	70Hz	31.469	70.087	28.322	-/+

MAC

Resolution (DotsxLines)	Display Format	Horizontal Frequency (KHz)	Vertical Frequency (Hz)	Clock Frequency (MHz)	Polarity (Horizontal/Vertical)
640x480	67Hz	35.000	66.667	30.240	-/-
832x624	75Hz	49.726	74.551	57.284	-/-
1152x870	75Hz	68.681	75.062	100.000	-/-

VESA DMT

Resolution (DotsxLines)	Display Format	Horizontal Frequency (KHz)	Vertical Frequency (Hz)	Clock Frequency (MHz)	Polarity (Horizontal/Vertical)
640x480	60Hz	31.469	59.940	25.175	-/-
640x480	72Hz	37.861	72.809	31.500	-/-
640x480	75Hz	37.500	75.000	31.500	-/-
800x600	60Hz	37.879	60.317	40.000	+/+
800x600	72Hz	48.077	72.188	50.000	+/+
800x600	75Hz	46.875	75.000	49.500	+/+
1024x768	60Hz	48.363	60.004	65.000	-/-
1024x768	70Hz	56.476	70.069	75.000	-/-
1024x768	75Hz	60.023	75.029	78.750	+/+
1152x864	75Hz	67.500	75.000	108.000	+/+
1280x720	60Hz	45.000	60.000	74.250	+/+
1280x800	60Hz	49.702	59.810	83.500	-/+
1280x1024	60Hz	63.981	60.020	108.000	+/+
1280x1024	75Hz	79.976	75.025	135.000	+/+
1366x768	60Hz	47.712	59.790	85.500	+/+
1440x900	60Hz	55.935	59.887	106.500	-/+
1600x900RB	60Hz	60.000	60.000	108.000	+/+
1680x1050	60Hz	65.290	59.954	146.250	-/+
1920x1080	60Hz	67.500	60.000	148.500	+/+

Supported Resolutions for Video Signals

CEA-861

Resolution (DotsxLines)	Display Format	Horizontal Frequency (KHz)	Vertical Frequency (Hz)	Clock Frequency (MHz)	Polarity (Horizontal/Vertical)
720(1440)x480i	60Hz	15.734	59.940	27.000	-/-
720(1440)x576i	50Hz	15.625	50.000	27.000	-/-
720x480	60Hz	31.469	59.940	27.000	-/-
720x576	50Hz	31.250	50.000	27.000	-/-
1280x720	60Hz	45.000	60.000	74.250	+/+
1280x720	50Hz	37.500	50.000	74.250	+/+
1920x1080i	60Hz	33.750	60.000	74.250	+/+
1920x1080i	50Hz	28.125	50.000	74.250	+/+
1920x1080	60Hz	67.500	60.000	148.500	+/+
1920x1080	50Hz	56.250	50.000	148.500	+/+
1920x1080	30Hz	33.750	30.000	74.250	+/+
1920x1080	25Hz	28.125	25.000	74.250	+/+
1920x1080	24Hz	27.000	24.000	74.250	+/+

License



DivX Certified® to play DivX® video up to HD 1080p, including premium content.

ABOUT DIVX VIDEO: DivX® is a digital video format created by DivX, LLC, a subsidiary of Rovi Corporation. This is an official DivX Certified® device that has passed rigorous testing to verify that it plays DivX video. Visit divx.com for more information and software tools to convert your files into DivX videos.

ABOUT DIVX VIDEO-ON-DEMAND: This DivX Certified® device must be registered in order to play purchased DivX Video-on-Demand (VOD) movies. To obtain your registration code, locate the DivX VOD section in your device setup menu. Go to vod.divx.com for more information on how to complete your registration.

DivX®, DivX Certified® and associated logos are trademarks of Rovi Corporation or its subsidiaries and are used under license.

Covered by one or more of the following U.S. patents: 7,295,673; 7,460,668; 7,515,710; 7,519,274



Manufactured under a license from U.S. Patent No's: 5,956,674, 5,974,380, 5,978,762, 6,487,535, 6,226,616, 7,212,872, 7,003,467, 7,272,567, 7,668,723, 7,392,195, 7,930,184, 7,333,929 and 7,548,853. DTS, the Symbol, and DTS and the Symbol together are registered trademarks & DTS Premium Sound | 5.1 is a trademark of DTS, Inc. ©2012 DTS, Inc. All Rights Reserved.



Manufactured under license from Dolby Laboratories.

Dolby and the double-D symbol are trademarks of Dolby Laboratories.



The terms HDMI and HDMI High-Definition Multimedia Interface, and the HDMI Logo are trademarks or registered trademarks of HDMI Licensing LLC in the United States and other countries.

Open Source License Notice

Open Source used in this product can be found on the following webpage.

(<http://opensource.samsung.com>) Open Source License Notice is written only English.



Glossary

- **480i/480p/720p/1080i/1080p**

Generally refers to the number of effective scanning lines that determines the screen's resolution. There are two scanning methods: interlaced and progressive.

- Scanning

Sequential projection of pixels to form images. The higher the number of pixels, the clearer and more vivid the images.

- Progressive

A sequential scanning method that scans every line, one after another.

- Interlaced

A staggered scanning method that scans every other line until the end of the screen and then fills in the remaining lines.

Example) If the number of horizontal scan lines is 480i

Scans 240 lines from start to finish and then scans the remaining 240 lines for a total of 480 lines.

* General differences between 480i and 480p are as follows:

	480i	480p
Horizontal Frequency	15.75Khz	31.5Khz
FPS	30	60
Lines on Screen	480	480

- **ARC (Audio Return Channel)**

ARC lets the TV output digital sound to an audio device and input digital sound from the same audio device through one HDMI cable. However, ARC is only available through the HDMI (ARC) port and only when the TV is connected to an ARC-enabled AV receiver.

- **DVI (Digital Visual Interface)**

Connecting the TV's DVI connector to a computer's DVI connector via an HDMI-to-DVI cable lets you use the TV as a computer monitor. However, HDMI-to-DVI cables deliver video signals only. You must connect a set of speakers to the computer using a separate cable to hear the computer's audio.

- **HDMI (High Definition Multimedia Interface)**

HDMI is a method of transmitting both video and audio signals via a single cable.

- **Dynamic versus Static IP Addresses**

If the network requires a dynamic IP address, use an ADSL modem or router that supports the Dynamic Host Configuration Protocol (DHCP). Modems and routers that support DHCP automatically provide the IP address, subnet mask, gateway and DNS values the TV needs to access the Internet, so they do not have to be entered manually. Most home networks use a dynamic IP address.

If the network requires a static IP address, enter the IP address, subnet mask, gateway, and DNS values manually when setting up the network connection. To get the IP address, subnet mask, gateway and DNS values, contact your Internet Service Provider (ISP).

If the network requires a static IP address, use an ADSL modem that supports DHCP. ADSL modems that support DHCP also allow static IP addresses.

- **Ethernet**

Ethernet is a LAN (Local Area Network) that uses coaxial cables standardized by the IEEE.

- **Component Connection**

Component connections are mostly used for game consoles and transmit the video signal by splitting it into a luminance signal (Y) and two color signals (Pb and Pr). The connector is marked as [Component IN]_(Pr, Pb, Y) on the back of the TV. On some devices, it is sometimes marked as Cr, Cb, Y. Cb and Cr are the digital conversions of the Pb and Pr signals.

The connectors are normally color-coded red (R), blue (B), and green (G) and offer the best picture quality possible for an analog connection.